

## Gynäkologie

## Gynaecology

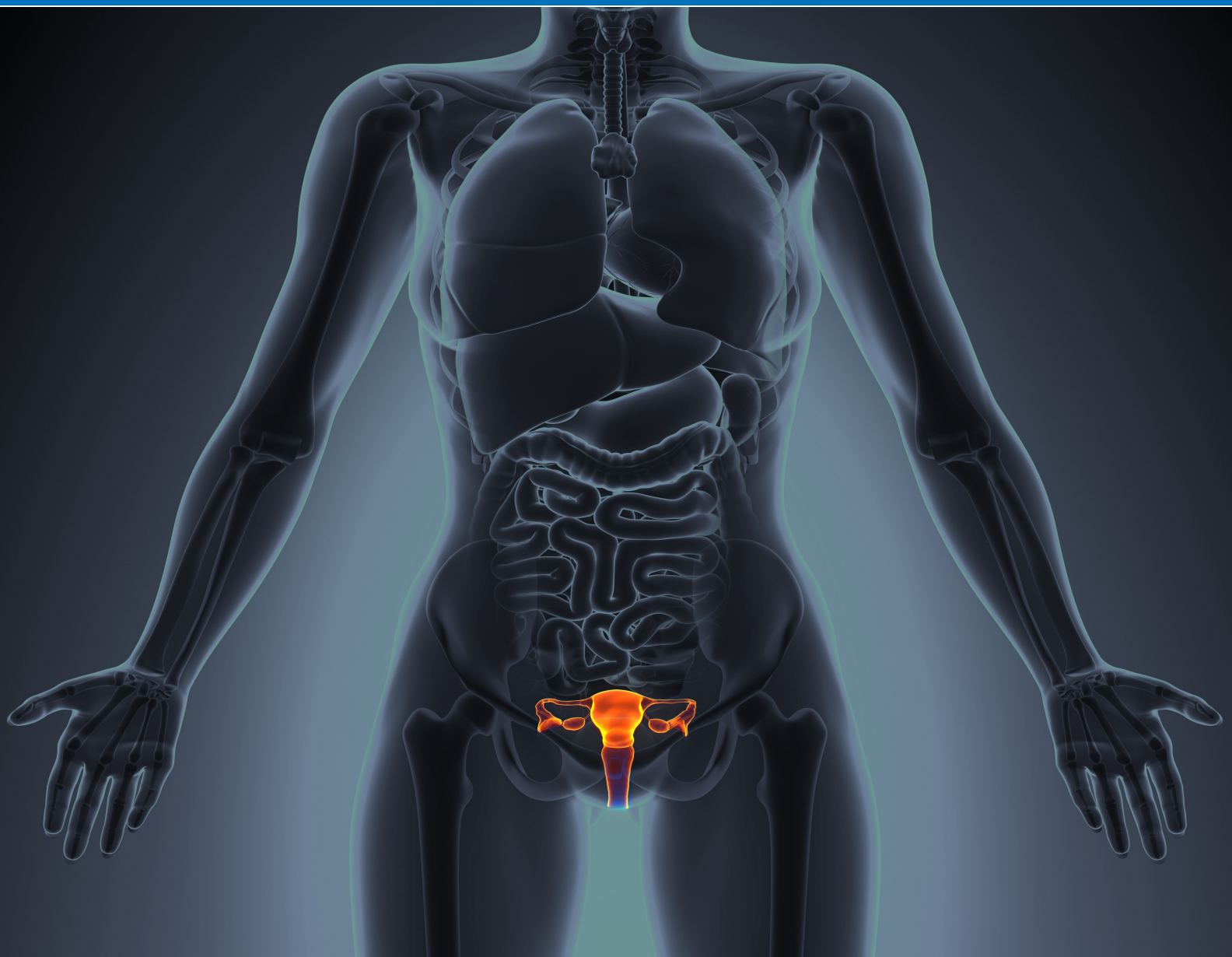

# Endoskope

---

## *Endoscopes*

**Technische Merkmale**  
*Technical Features*

---

- Perfektes, ergonomisches Design**  
Perfect, ergonomic design
- Hergestellt aus korrosionsfreiem Edelstahl**  
Made of non-corrosive stainless steel
- Autoklavierbar (134°C/273°F)**  
Autoclavable (134°C/273°F)
- Extrem widerstandsfähig & beständig**  
Extremely resistant & durable
- Distale & proximale Decklinsen aus Saphirglas hergestellt**
  - > **Kratzresistent!**  
Distal & proximal lenses are made of Sapphire glass
  - > scratch resistant!
- Verzerrungsfreies & kristallklares Bild**  
Distortion-free & crystal clear image
- Mechanische Komponenten & Verbindungen sind lasergeschweißt oder geklebt**  
Mechanical components & connections are laser-welded or glued
- Kompatibel auch mit anderen Herstellern**
  - > Compatible also with other brands
- Verschiedene Blickrichtungen farblich klar gekennzeichnet**  
Various viewing directions clearly marked with colour-codes
- 2 Jahre Garantie**  
2 years guarantee
- Exzellenter Reparatur- & Kundendienst-Service**
  - > Excellent repair & after sales service

**Endoskope, starr**  
Endoscopes, rigid

# Hysteroskope

## Hysteroscopes



## Technische Daten

Technical Data

Hysteroskop Ø 2.8 mm / Hysteroscope Ø 2.8 mm



Artikel Nr. / Item no.	HS28A.01	HS28B.01
Durchmesser / Diameter	Ø 2.8 mm	Ø 2.8 mm
Kompatibel / Compatible	Storz®	Storz®
Nutzlänge / Working length	302,5 mm	302,5 mm
Blickrichtung / Direction of view	0°	30°

Artikel Nr. / Item no.	HS28C.01	HS28F.01
Durchmesser / Diameter	Ø 2.8 mm	Ø 2.8 mm
Kompatibel / Compatible	Storz®	Storz®
Nutzlänge / Working length	302,5 mm	302,5 mm
Blickrichtung / Direction of view	70°	12°

Hysteroskop Ø 4.0 mm / Hysteroscope Ø 4.0 mm

Artikel Nr. / Item no.	HS40A.01	HS40B.01
Durchmesser / Diameter	Ø 4.0 mm	Ø 4.0 mm
Kompatibel / Compatible	Storz®	Storz®
Nutzlänge / Working length	302,5 mm	302,5 mm
Blickrichtung / Direction of view	0°	30°

Artikel Nr. / Item no.	HS40C.01	HS40F.01
Durchmesser / Diameter	Ø 4.0 mm	Ø 4.0 mm
Kompatibel / Compatible	Storz®	Storz®
Nutzlänge / Working length	302,5 mm	302,5 mm
Blickrichtung / Direction of view	70°	12°

# OP-Hysteroskop

## OP hysteroscope



## Technische Daten

### Technical Data

Standard Form / Standard Style		HX5731F.01
instrument size (Charr.):	Länge / Length	191 mm
	Außenrohr / Outer tube dim.	4,4 mm
	Arbeitskanal / Working channel	9,3 Charr.
	Blickrichtung / Direction of view	12°
	Öffnungswinkel / Field of view	75°
	Bildpunkte / Pixel	Rod lens system
	Modell / Model	Bichler
	Artikel Nr. / Item no.	HX5731F.01



Zubehör / accessories	Artikel Nr. / Item no.
Außenschaft mit 2 starren Hähnen, 19 Charr. / Outer sheath with 2 fixed stopcocks (Quick lock), 19 Fr.	370.00978.00

**Kaltlichtkabel, HTT**  
*Cold Light Cables, HTT*



Artikelnummer / Item No.	Durchmesser / Diameter	Farbe / Colour	VE / PU
LC351800	Ø 3,5mm x 1800mm	■	1Stk/pc
LC351800S	Ø 3,5mm x 1800mm, Input plug curved 90°	■	1Stk/pc
LC352300	Ø 3,5mm x 2300mm	■	1Stk/pc
LC353000	Ø 3,5mm x 3000mm	■	1Stk/pc
LC481800	Ø 4,8mm x 1800mm	■	1Stk/pc
LC482300	Ø 4,8mm x 2300mm	■	1Stk/pc
LC483000	Ø 4,8mm x 3000mm	■	1Stk/pc

HTT: High Transmission Technology  
Verschmolzene Glasfasern / Fused optical fibreglass

**Merkmale / Features**

**Optische Qualitätsglasfasern**  
High-end optical fibreglass

**Hohe Lichttransmission und Temperaturbeständigkeit (20 % mehr Lichttransmission gegenüber Standard-Lichtleitkabeln)**  
High light transmission and temperature-resistance (20 % more light transmission compared to standard light guide cables)

**Zugentlastung und innenliegender Knickschutz für eine lange Lebensdauer**  
Stress relief and inner bending protection for a long life span

**Hohe Flexibilität**  
High flexibility

**Austauschbares Adaptersystem ohne Lichtverluste**  
Exchangeable adaptor system without light losses

**Anwendbar für alle marktüblichen Kaltlichtquellen und Endoskope**  
Applicable to all commercially available light sources and endoscopes

**Autoklavierbar**  
Autoclavable

**Adapter für Kaltlichtkabel**  
Adaptors for Cold Light Cables



Bild / Picture	Artikelnummer / Item No.	Beschreibung / Description	Kompatibel / Com- patibel	VE / PU
	LCIS	Adapter LE / Adapter LE	Storz®	1Stk/pc
	LCIW	Adapter LE / Adapter LE	Wolf®	1Stk/pc
	LCIO	Adapter LE / Adapter LE	Olympus®	1Stk/pc
	LCOSO	Adapter LA / Adapter LA	Storz® / Olympus®	1Stk/pc
	LCOW	Adapter LA / Adapter LA	Wolf®	1Stk/pc
	LCIP	Adapter LE / Adapter LE	Pentax®	1Stk/pc

# Hysteroskopie

## *Hysteroscopy*



### CO<sub>2</sub>-Hysteroskopschäfte – diagnostisch

CO<sub>2</sub> Hysteroscope Sheaths – diagnostic



Schaftsystem für Endoskopblickrichtungen Sheath system for endoscope viewing directions			Durchmesser Diameter	Nutzlänge Working length	Kennfarbe Colour Code	Bestell-Nr. Ordering number	
						Schaft Sheath	Obturator Obturator
0°	oder or	12°	5,0 mm	270 mm	blau/blue	AHY010-040-302	AHY011-040-302
30°						AHY010-140-302	

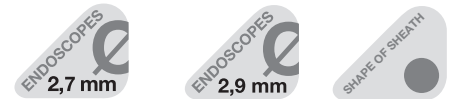

Schaftsystem für Endoskopblickrichtungen Sheath system for endoscope viewing directions			Durchmesser Diameter	Nutzlänge Working length	Kennfarbe Colour Code	Bestell-Nr. Ordering number	
						Schaft Sheath	Obturator Obturator
0°			4,0 mm	270 mm	weiß/white	AHY020-029-302	AHY021-029-302
30°						AHY020-129-302	

**CO<sub>2</sub>-Hysteroskopschäfte – diagnostisch**  
*CO<sub>2</sub> Hysteroscope Sheaths – diagnostic*



Schaftsystem für Endoskopblickrichtungen Sheath system for endoscope viewing directions	Durchmesser Diameter	Nutzlänge Working length	Kennfarbe Colour Code	Bestell-Nr. Ordering number	
				Schaft Sheath	Obturator Obturator
0°	2,9 mm	224 mm	rot/red	AHY030-020-260	AHY031-020-260
30°				AHY030-120-260	

### Dauerspül-Hysteroskopschaftsysteme – diagnostisch

*Continuous-Flow Hysteroscope Sheath Systems – diagnostic*

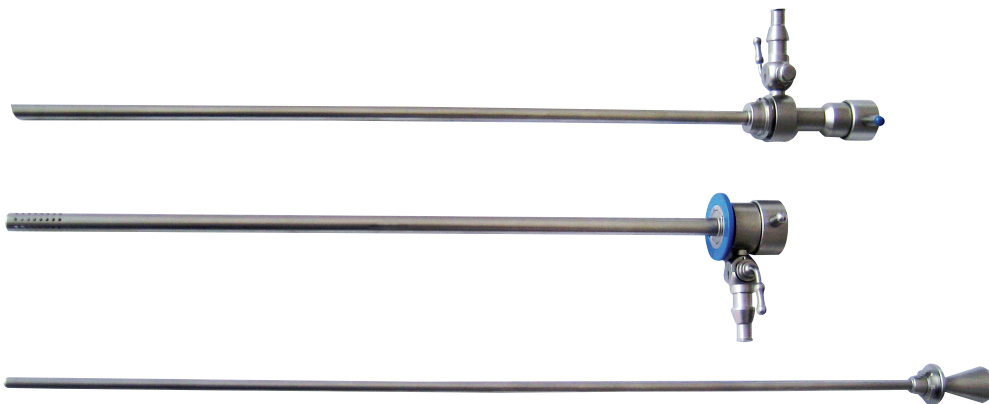

Schaftsystem für Endoskopblickrichtungen Sheath system for endoscope viewing directions			Durchmesser Diameter		Nutzlänge Working length		Kernfarbe Colour Code	Bestell-Nr. Ordering number		
			Innenschaft Inner Sheath	Außenschaft Outer Sheath	Nur Innenschaft Inner Sheath only	Mit Außenschaft With Outer Sheath		Innenschaft Inner Sheath	Außenschaft Outer Sheath	Obturator für Innenschaft Obturator for Inner Sheath
0°	oder or	12°	5,5 mm	6,5 mm	260 mm	240 mm	blau/blue	AHY110-040-302	AHY111-040-302	AHY011-040-302
30°								AHY110-140-302		

### Dauerspül-Hysteroskopschaftsysteme – diagnostisch

*Continuous-Flow Hysteroscope Sheath Systems – diagnostic*

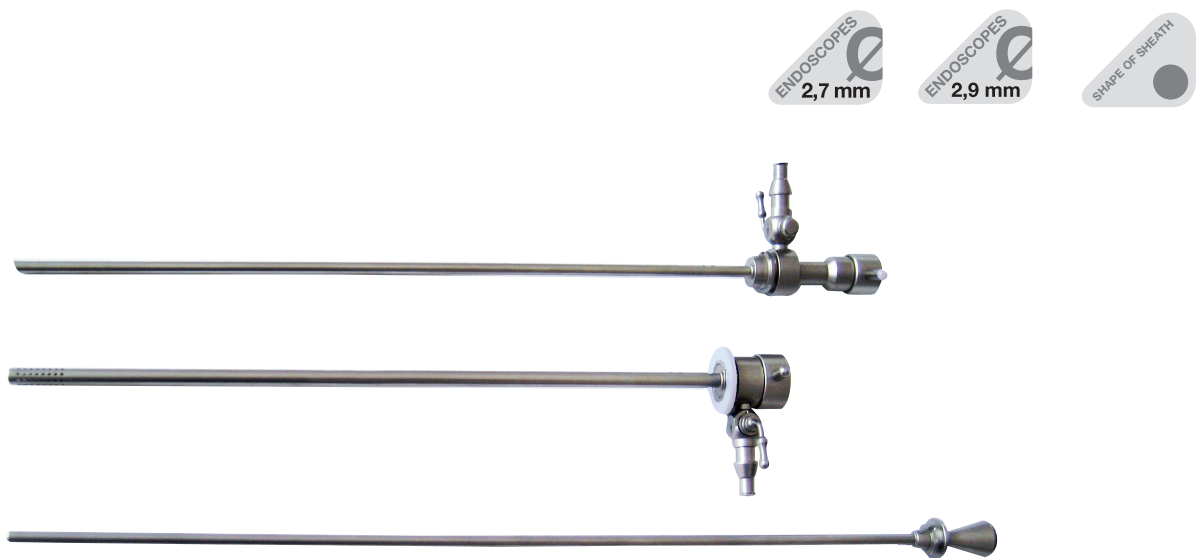

Schaftsystem für Endoskopblick- richtungen Sheath system for endoscope viewing directions	Durchmesser Diameter		Nutzlänge Working length		Kennfarbe Colour Code	Bestell-Nr. Ordering number		
	Innenschaft Inner Sheath	Außenschaft Outer Sheath	Nur Innenschaft Inner Sheath only	Mit Außenschaft With Outer Sheath		Innenschaft Inner Sheath	Außenschaft Outer Sheath	Obturator für Innenschaft Obturator for Inner Sheath
0°	4,0 mm	5,0 mm	260 mm	240 mm	weiß/white	AHY120-029-302	AHY121-029-302	AHY021-029-302
30°						AHY120-129-302		

### Dauerspül-Hysteroskopschaftsysteme – diagnostisch

*Continuous-Flow Hysteroscope Sheath Systems – diagnostic*

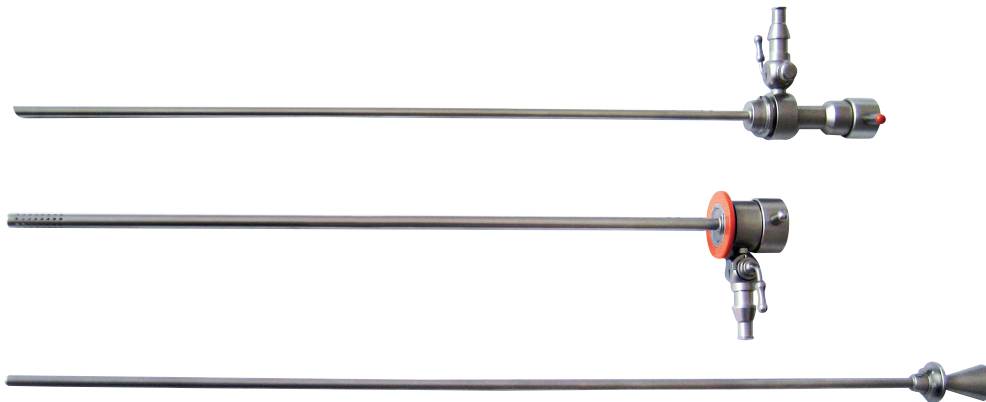

Schaftsystem für Endoskopblick- richtungen Sheath system for endoscope viewing directions	Durchmesser Diameter		Nutzlänge Working length		Kennfarbe Colour Code	Bestell-Nr. Ordering number		
	Innenschaft Inner Sheath	Außenschaft Outer Sheath	Nur Innenschaft Inner Sheath only	Mit Außenschaft With Outer Sheath		Innenschaft Inner Sheath	Außenschaft Outer Sheath	Obturator für Innenschaft Obturator for Inner Sheath
0°	2,9 mm	3,4 mm	218 mm	200 mm	rot/red	AHY130-020-260	AHY131-020-260	AHY031-020-260
30°						AHY130-120-260		

### Standard Dauerspül-Hysteroskopschäfte, operativ

*Standard Continuous-Flow Hysteroscope Sheaths, operative*

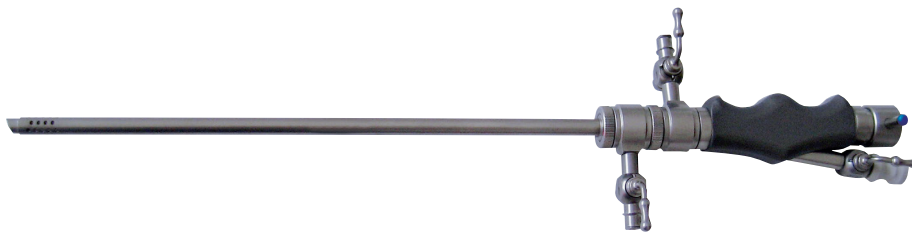
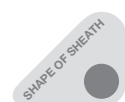
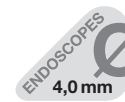

Schaftsystem für Endoskopblickrichtungen Sheath system for endoscope viewing directions			Durchmesser Diameter	Nutzlänge Working length	Kennfarbe Colour Code	Durchlass Instrumentenkanal Capacity of instrument channel	Bestell-Nr. Ordering number
							Schaft Sheath
0°	oder or	12°	8,0 mm	200 mm	blau/blue	7 Charr./Fr.	AHY210-040-302
30°							AHY210-140-302

**Standard Dauerspül-Hysteroskopschäfte, operativ**  
*Standard Continuous-Flow Hysteroscope Sheaths, operative*



Schaftsystem für Endoskopblickrichtungen Sheath system for endoscope viewing directions	Durchmesser Diameter	Nutzlänge Working length	Kennfarbe Colour Code	Durchlass Instrumentenkanal Capacity of instrument channel	Bestell-Nr. Ordering number
					Schaft Sheath
0°	6,0 mm	200 mm	weiß/white	5 Charr./Fr.	AHY220-029-302
30°					AHY220-129-302

### Dauerspül-Hysteroskopschaftsystem, operativ

*Continuous-Flow Hysteroscope Sheath System, operative*

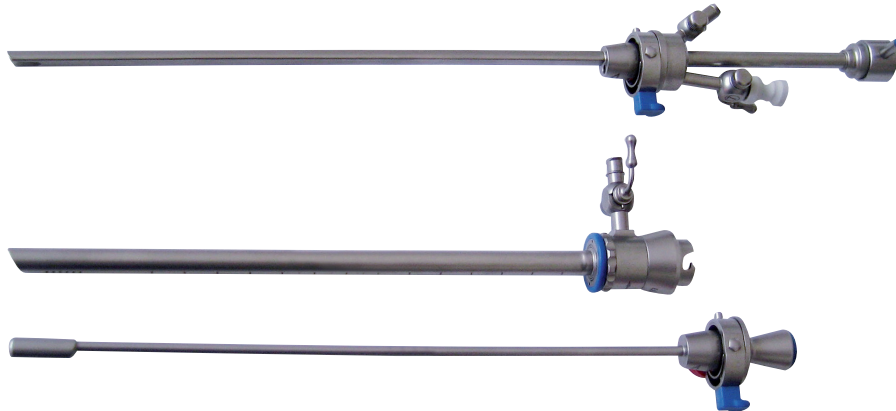

Schaftsystem für Endoskopblick- richtungen Sheath system for endoscope viewing directions	Durchmesser Diameter	Nutzlänge mit Außenschaft Working length with Outer Sheath	Weitere Details Further details		Bestell-Nr. Ordering number		
			Kennfarbe Colour code	Durchlass Instr.-Kanal Capacity of instr. channel	Innenschaft Inner Sheath	Außenschaft Outer Sheath	Obturator für Außenschaft Obturator for Outer Sheath
30° 12°	8,0 x 6,8 mm	184 mm	blau/blue	7 Charr./Fr.	AHY240-040-302	AHY241-040-302	AHY242-040-302

### Dauerspül-Hysteroskopschaftsysteme, operativ

*Continuous-Flow Hysteroscope Sheath Systems, operative*

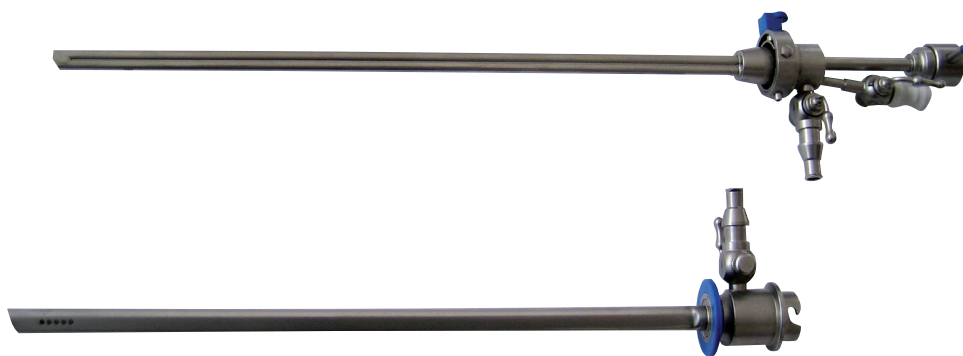
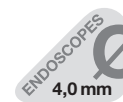

Schaftsystem für Endoskopblick- richtungen Sheath system for endoscope viewing directions	Durchmesser Diameter		Nutzlänge Working length		Weitere Details Further details		Bestell-Nr. Ordering number	
	Innenschaft Inner Sheath	Außenschaft Outer Sheath	Innenschaft Inner Sheath	Außenschaft Outer Sheath	Kennfarbe Colour code	Durchlass Instr.-Kanal Capacity of instr. channel	Innenschaft Inner Sheath	Außenschaft Outer Sheath
30°	-	7,3 x 5,6 mm	-	192 mm	blau/blue	5 Charr./Fr.	AHY250-040-302	AHY251-040-302
12°	-	7,9 x 5,2 mm	-	192 mm	grün/green	7 Charr./Fr.	AHY254-040-302	AHY255-040-302

**Dauerspül-Hysteroskopschaftsysteme, operativ, atraumatisch**  
*Continuous-Flow Hysteroscope Sheath Systems, operative, atraumatic*

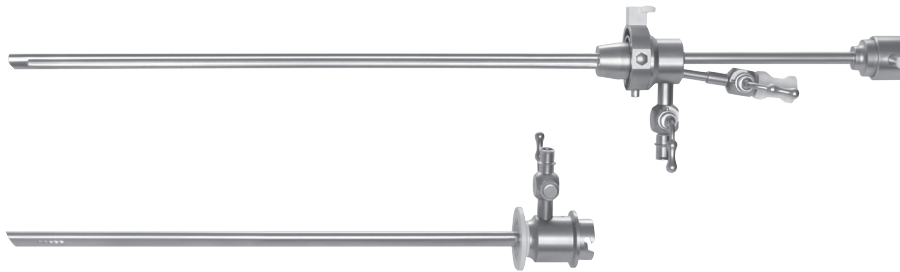

Schaftsystem für Endoskopblick- richtungen Sheath system for endoscope viewing directions	Durchmesser Diameter		Nutzlänge Working length		Weitere Details Further details		Bestell-Nr. Ordering number	
	Innenschaft Inner Sheath	Außenschaft Outer Sheath	Innenschaft Inner Sheath	Außenschaft Outer Sheath	Kennfarbe Colour code	Durchlass Instr.-Kanal Capacity of instr. channel	Innenschaft Inner Sheath	Außenschaft Outer Sheath
30°	-	6,0 x 4,2 mm	-	190 mm	weiß/white	5 Charr./Fr.	AHY260-029-302	AHY261-029-302
				235 mm			AHY264-029-302	AHY265-029-302

**Dauerspül-Hysteroskopschaftsystem, operativ, atraumatisch**  
*Continuous-Flow Hysteroscope Sheath System, operative, atraumatic*

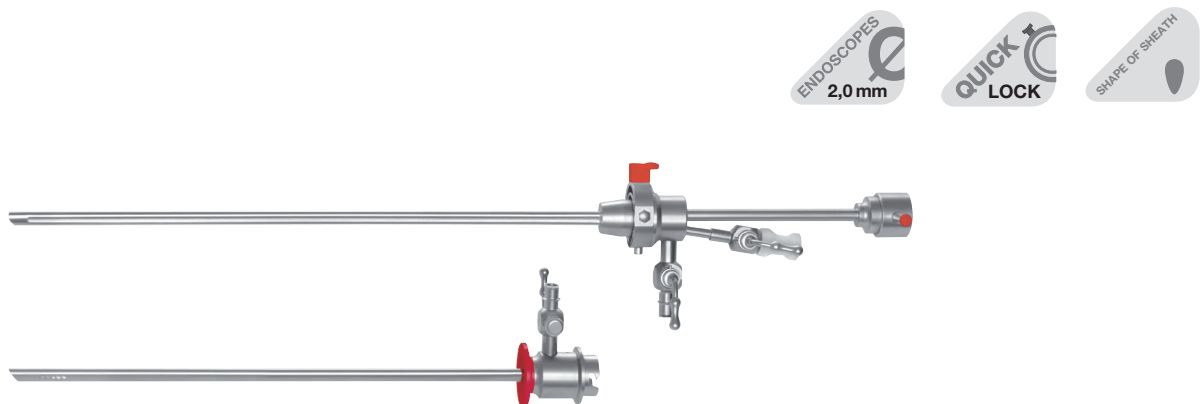

Schaftsystem für Endoskopblick- richtungen Sheath system for endoscope viewing directions	Durchmesser Diameter		Nutzlänge Working length		Weitere Details Further details		Bestell-Nr. Ordering number	
	Innenschaft Inner Sheath	Außenschaft Outer Sheath	Innenschaft Inner Sheath	Außenschaft Outer Sheath	Kennfarbe Colour code	Durchlass Instr.-Kanal Capacity of instr. channel	Innenschaft Inner Sheath	Außenschaft Outer Sheath
30°	-	4,5 x 3,4 mm	-	190 mm	rot/red	5 Charr./Fr.	AHY270-020-260	AHY271-020-260

## Dauerspül-Hysteroskopschaft, operativ Continuous-Flow Hysteroscope Sheath, operative



Schaftsystem für Endoskopblickrichtungen Sheath system for endoscope viewing directions	Durchmesser Diameter	Nutzlänge Working length	Weitere Details Further details		Bestell-Nr. Ordering number
			Kennfarbe Colour code	Durchlass Instrumentenkanal Capacity of instrument channel	Schaft Sheath
30°	5,5 mm	210 mm	weiß/white	5 Charr./Fr.	AHY280-029-302

**Zangen, flexibel, isoliert und halbstarr**  
*Forceps, flexible, insulated and semi-rigid*



Nutzlänge 340 mm Working length 340 mm	Durchmesser / Diameter		flexibel flexible	flexibel isoliert flexible insulated	halbstarr semi-rigid
	mm	Charr. / Fr.			

**Fremdkörperzange, Alligatormaul, doppelbeweglich / Foreign body forceps, alligator jaw, double action**

	1,0	3	AFF204-210-034		AFF204-610-034
	1,6	5	AFF204-216-034	AFF204-416-034	AFF204-616-034
	2,3	7	AFF204-223-034	AFF204-423-034	AFF204-623-034
	3,0	9	AFF204-230-034	AFF204-430-034	AFF204-630-034

**Probeexzisions- und Fasszange, oval, gezahnt, doppelbeweglich / Biopsy and grasping forceps, oval, serrated, double action**

	1,6	5	AFF203-216-034	AFF203-416-034	AFF203-616-034
	2,1	6	AFF203-221-034	AFF203-421-034	AFF203-621-034
	2,3	7	AFF203-223-034	AFF203-423-034	AFF203-623-034
	3,0	9	AFF203-230-034	AFF203-430-034	AFF203-630-034

**Fasszange für Steinstrasse, doppelbeweglich / Grasping forceps for large stone fragments, double action**

	1,6	5	AFF208-216-034	AFF208-416-034	AFF208-616-034

**Probeexzisionszange, oval, doppelbeweglich / Biopsy forceps, oval, double action**

	1,0	3	AFF200-210-034		AFF200-610-034
	1,6	5	AFF200-216-034	AFF200-416-034	AFF200-616-034
	2,1	6	AFF200-221-034	AFF200-421-034	AFF200-621-034
	2,3	7	AFF200-223-034	AFF200-423-034	AFF200-623-034
	3,0	9	AFF200-230-034	AFF200-430-034	AFF200-630-034

Weitere Modelle auf Anfrage.  
 Further models upon request.

**Zangen, flexibel, isoliert und halbstarr**  
*Forceps, flexible, insulated and semi-rigid*



Nutzlänge 340 mm Working length 340 mm	Durchmesser / Diameter		flexibel flexible	flexibel isoliert flexible insulated	halbstarr semi-rigid
	mm	Charr. / Fr.			

**Schere, einfachbeweglich / Scissors, single action**



1,6	5	AFF201-216-034	AFF201-416-034	AFF201-616-034
2,1	6	AFF201-221-034	AFF201-421-034	AFF201-621-034
2,3	7	AFF201-223-034	AFF201-423-034	AFF201-623-034
3,0	9	AFF201-230-034	AFF201-430-034	AFF201-630-034

**Hakenschere, einfachbeweglich / Hook scissors, single action**



2,3	7	AFF202-223-034	AFF202-423-034	AFF202-623-034
3,0	9	AFF202-230-034	AFF202-430-034	AFF202-630-034

**Schere, doppelbeweglich / Scissors, double action**

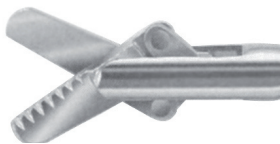

2,3	7	AFF205-223-034	AFF205-423-034	AFF205-623-034

Weitere Modelle auf Anfrage.  
 Further models upon request.

**Zangen, flexibel, isoliert und halbstarr**  
*Forceps, flexible, insulated and semi-rigid*



Nutzlänge 400 mm Working length 400 mm	Durchmesser / Diameter		flexibel flexible	flexibel isoliert flexible insulated	halbstarr semi-rigid
	mm	Charr. / Fr.			

**Fremdkörperzange, Alligatormaul, doppelbeweglich / Foreign body forceps, alligator jaw, double action**

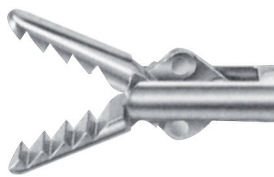

1,0	3	AFF204-210-040		AFF204-610-040
1,6	5	AFF204-216-040	AFF204-416-040	AFF204-616-040
2,3	7	AFF204-223-040	AFF204-423-040	AFF204-623-040
3,0	9	AFF204-230-040	AFF204-430-040	AFF204-630-040

**Probeexzisions- und Fasszange, oval, gezahnt, doppelbeweglich / Biopsy and grasping forceps, oval, serrated, double action**

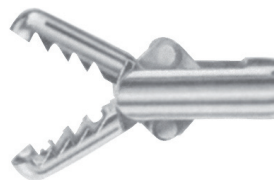

1,6	5	AFF203-216-040	AFF203-416-040	AFF203-616-040
2,1	6	AFF203-221-040	AFF203-421-040	AFF203-621-040
2,3	7	AFF203-223-040	AFF203-423-040	AFF203-623-040
3,0	9	AFF203-230-040	AFF203-430-040	AFF203-630-040

**Fasszange für Steinstrasse, doppelbeweglich / Grasping forceps for large stone fragments, double action**



1,6	5	AFF208-216-040	AFF208-416-040	AFF208-616-040

**Probeexzisionszange, oval, doppelbeweglich / Biopsy forceps, oval, double action**

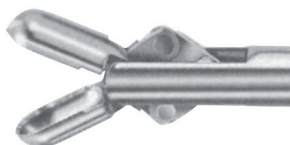

1,0	3	AFF200-210-040		AFF200-610-040
1,6	5	AFF200-216-040	AFF200-416-040	AFF200-616-040
2,1	6	AFF200-221-040	AFF200-421-040	AFF200-621-040
2,3	7	AFF200-223-040	AFF200-423-040	AFF200-623-040
3,0	9	AFF200-230-040	AFF200-430-040	AFF200-630-040

Weitere Modelle auf Anfrage.  
 Further models upon request.

**Zangen, flexibel, isoliert und halbstarr**  
*Forceps, flexible, insulated and semi-rigid*



Nutzlänge 400 mm Working length 400 mm	Durchmesser / Diameter		flexibel flexible	flexibel isoliert flexible insulated	halbstarr semi-rigid
	mm	Charr. / Fr.			

**Schere, einfachbeweglich / Scissors, single action**

	1,6	5	AFF201-216-040	AFF201-416-040	AFF201-616-040
	2,1	6	AFF201-221-040	AFF201-421-040	AFF201-621-040
	2,3	7	AFF201-223-040	AFF201-423-040	AFF201-623-040
	3,0	9	AFF201-230-040	AFF201-430-040	AFF201-630-040

**Hakenschere, einfachbeweglich / Hook scissors, single action**

	2,3	7	AFF202-223-040	AFF202-423-040	AFF202-623-040
	3,0	9	AFF202-230-040	AFF202-430-040	AFF202-630-040

**Schere, doppelbeweglich / Scissors, double action**

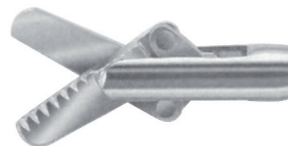
	2,3	7	AFF205-223-040	AFF205-423-040	AFF205-623-040

Weitere Modelle auf Anfrage.  
 Further models upon request.

**Diathermie-Schlingen**  
Diathermy Loops

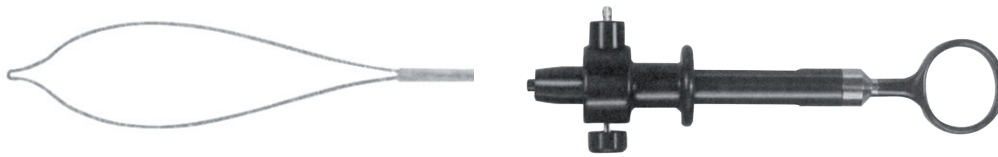

**Diathermieschlinge / Diathermy Loop**



1,6	5	-	500 mm	AHI110-416-050
2,3	7	-	500 mm	AHI110-423-050

**Griff alleine, mit HF-Anschluss für Diathermieschlinge / Handle only, with HF-Connection for Diathermy Loop**



1,6	5	-	500 mm	AHI110-000-000
2,3	7	-	500 mm	

### Flexible Elektroden, Bipolar

*Flexible Electrodes, Bipolar*

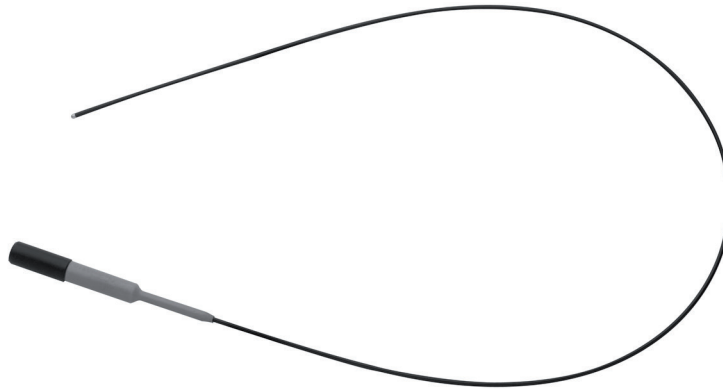

#### Nadelelektrode / Needle Electrode



Durchmesser / Diameter		Nutzlänge / Working length	Bestell-Nr. / Ordering number
mm	Charr. / Fr.		
1,0	3	450 mm	AHI010-410-045B
1,6	5	450 mm	AHI010-416-045B
2,3	7	450 mm	AHI010-423-045B

#### Knopfelektrode / Button Electrode



1,0	3	450 mm	AHI020-410-045B
1,3	4	450 mm	AHI020-413-045B
1,6	5	450 mm	AHI020-416-045B
2,3	7	450 mm	AHI020-423-045B
2,6	8	450 mm	AHI020-426-045B
3,0	9	450 mm	AHI020-430-045B
3,3	10	450 mm	AHI020-433-045B

#### Schlingenelektrode / Loop Electrode



1,6	5	450 mm	AHI030-416-045B
2,3	7	450 mm	AHI030-423-045B
3,0	9	450 mm	AHI030-430-045B

Weitere Nutzlängen auf Anfrage.  
Further working lengths upon request.

### Hochfrequenz-Kabel, *Bipolar*

#### High-Frequency Cables, *Bipolar*









instrumentenseitig instrument side	geräteseitig equipment side	Durchmesser Diameter	Länge Length	Bestell-Nr. Ordering number
		4,0 mm	3 m	AHC010-040-300B
Für Geräte von Berchtold, Martin, Aesculap/For Berchtold, Martin, Aesculap units				
		4,0 mm	3 m	AHC012-040-300B
Für Geräte von Berchtold, Martin, Erbe T-Serie/For Berchtold, Martin, Erbe T-Series units				
		5,0 mm	3 m	AHC014-050-300B
Für Geräte von Erbe ACC/ICC, Storz/For Erbe ACC/ICC, Storz units				
		8,0 mm	3 m	AHC016-080-300B
Für Geräte von Valleylab, Bovie, Conmed/For Valleylab, Bovie, Conmed units				

Weitere Kabel auf Anfrage. / Further cables upon request.

### Basis-Set für Hysteroskopie – diagnostisch

*Basic Set for Hysteroscopy – diagnostic*



Artikelbezeichnung Article description	Stückzahl Quantity	Produkt Product	Bestell-Nr. Ordering number
Komplett-Set Complete Set			ASE260-010-010
Hysteroskopschaft – diagnostisch, 12°-30°; D = 5,5 mm; NL = 260 mm Hysteroscope sheath – diagnostic, 12°-30°; d = 5,5 mm; WL = 260 mm	1		AHY110-140-302
HysteroskopAußenschaft für Dauerspülung; D = 6,5 mm; NL = 240 mm Hysteroscope outer sheath for continuous-flow; d = 6,5 mm; WL = 240 mm	1		AHY111-040-302
Standardobturator Standard obturator	1		AHY011-040-302
Endoskopiesiebkorb für 1 Endoskop, 460 x 80 x 55 mm Endoscope Wire Basket f. 1 endoscope, 460 x 80 x 55 mm	2		74-600-040
BARRETT Hakenzange, 180 mm BARRETT Tenaculum Forceps, 180 mm	1		370-506-180
SIMS Uterussonde, 32 cm, cm-Einteilung, graduert, starr SIMS Uterine Probe, 32 cm, with centimetre scale, graduated, rigid	1		62-501-320
HEGAR Dilatator-Satz (8 Stück), doppelendig HEGAR Dilating-Set (8 pcs), double-ended	1		370-420-080
CUSCO Scheidenspekula, 85 x 35 mm CUSCO Vaginal Specula, 85 x 35 mm	1		62-031-002

\*Passende Endoskope finden Sie in Unserem separaten Endoskopie Flyer .

\*Suitable Endoscopes can be found in our Endoscopy flyer.

### Basis-Set für Hysteroskopie – operativ

*Basic Set for Hysteroscopy – operative*







Artikelbezeichnung Article description	Stückzahl Quantity	Produkt Product	Bestell-Nr. Ordering number
Komplett-Set Complete Set			ASE260-110-010
Standard-OP-Dauerspül-Hysteroskopschaft mit 2 drehb. Hähnen und 7 Charr. Instr.-Kanal; 12°-30°; D = 8,0 mm; NL = 200 mm Standard OP continuous-flow hysteroscope sheath with 2 rotatable stopcocks and 7 Fr. instr. channel; 12°-30°; d = 8,0 mm; WL = 200 mm	1		AHY210-140-302
Flexible Schere, 400 mm, 7 Charr. Flexible scissors, 400 mm, 7 Fr.	1		AFF201-223-040
Flexible Hakenschere, 400 mm, 7 Charr. Flexible Hook scissors, 400 mm, 7 Fr.	1		AFF202-223-040
Flexible Probeexcisions- und Fasszange, 400 mm, 7 Charr. Flexible biopsy and grasping forceps, 400 mm, 7 Fr.	1		AFF203-223-040
Flexible Fremdkörperzange, Alligatormaul, 400 mm, 7 Charr. Flexible foreign body forceps, Alligator jaw, 400 mm, 7 Fr.	1		AFF204-223-040
Handgriff allein, mit HF Anschluss für Diathermie Schlinge Handle only, with HF plug for diathermy loop	1		AHI110-000-000
Diathermieschlinge allein, mit Teflontubus 7 Ch., 500 mm lang Diathermy loop only, with Teflon tubus 7 Fr., 500 mm long	1		AHI110-423-050
Flexible Knopfelektrode, 7 Charr. NL = 450 mm Flexible button electrode, 7 Fr., WL = 450 mm	1		AHI020-423-045
Flexible Nadelelektrode, 7 Charr. NL = 450 mm Flexible needle electrode, 7 Fr., WL = 450 mm	1		AHI010-423-045
Flexible Schlingenelektrode, 7 Charr. NL = 450 mm Flexible loop electrode, 7 Fr., WL = 450 mm	1		AHI030-423-045
HF-Kabel, monopolar, Martin, 4,0 mm, 3 m lang HF Cable, monopolar, Martin, 4,0 mm, 3 m long	1		AHC012-040-300
Endoskopiesiebkorb für 1 Endoskop, 460 x 80 x 55 mm Endoscope Wire Basket f. 1 endoscope, 460 x 80 x 55 mm	2		74-600-040

**\*Passende Endoskope finden Sie in Unserem separaten Endoskopie Flyer .**

*\*Suitable Endoscopes can be found in our Endoscopy flyer.*













**Basis-Set für Hysteroskopie – operativ**  
*Basic Set for Hysteroscopy – operative*

Artikelbezeichnung Article description	Stückzahl Quantity	Produkt Product	Bestell-Nr. Ordering number
BARRETT Hakenzange, 180 mm BARRETT Tenaculum Forceps, 180 mm	1		370-506-180
SIMS Uterussonde, 32 cm, cm-Einteilung, graduert, starr SIMS Uterine Probe, 32 cm, with centimetre scale, graduated, rigid	1		62-501-320
HEGAR Dilator-Satz (8 Stück), doppelendig HEGAR Dilating-Set (8 pcs), double-ended	1		370-420-080
CUSCO Scheidenspekula, 85 x 35 mm CUSCO Vaginal Specula, 85 x 35 mm	1		62-031-002

### Basis-Set für Hysteroskopie – operativ / atraumatisch – ambulant

*Basic Set for Hysteroscopy – operative / atraumatic – outpatient*







Artikelbezeichnung Article description	Stückzahl Quantity	Produkt Product	Bestell-Nr. Ordering number
Komplett-Set Complete Set	1		ASE260-110-040
OP-Untersuchungseinsatz, 5 Charr. Instrumenten-Kanal, 1 Spülhahn OP Examination insert, 5 Fr. instr. channel, 1x stopcock	1		AHY260-029-302
Außenschaft für Dauerspülung, 1 Hahn, D = 6,0 x 4,2 mm, NL = 190 mm, tropfenförmig Outer sheath for continuous-flow, 1 stopcock d = 6,0 x 4,2 mm, WL = 190 mm drop-shaped	1		AHY261-029-302
Flexible Schere, 340 mm, 5 Charr. Flexible scissors, 340 mm, 5 Fr.	1		AFF201-216-034
Flexible Probeexzisions- und Fasszange, 340 mm, 5 Charr. Flexible biopsy and grasping forceps, 340 mm, 5 Fr.	1		AFF203-216-034
Flexible Fremdkörperzange, Alligatormaul, 340 mm, 5 Charr. Flexible foreign body forceps, Alligator jaw, 340 mm, 5 Fr.	1		AFF204-216-034
Handgriff allein, mit HF Anschluss für Diathermie Schlinge Handle only, with HF plug for diathermy loop	1		AHI110-000-000
Diathermieschlinge allein, mit Teflontubus 5 Ch., 500 mm lang Diathermy loop only, with Teflon tubus 5 Fr., 500 mm long	1		AHI110-416-050
Flexible Knopfelektrode, 5 Charr. NL = 450 mm Flexible button electrode, 5 Fr., WL = 450 mm	1		AHI020-416-045
Flexible Nadelelektrode, 5 Charr. NL = 450 mm Flexible needle electrode, 5 Fr., WL = 450 mm	1		AHI010-416-045
Flexible Schlingenelektrode, 5 Charr. NL = 450 mm Flexible loop electrode, 5 Fr., WL = 450 mm	1		AHI030-416-045
HF-Kabel, monopolar, Martin, 4 mm, 3 m lang HF Cable, monopolar, Martin, 4 mm, 3 m long	1		AHC012-040-300
Endoskopiesiebkorb für 1 Endoskop, 460 x 80 x 55 mm Endoscope Wire Basket f. 1 endoscope, 460 x 80 x 55 mm	1		74-600-040

\*Passende Endoskope finden Sie in Unserem separaten Endoskopie Flyer .

\*Suitable Endoscopes can be found in our Endoscopy flyer.

**Basis-Set für Hysteroskopie – operativ / atraumatisch – ambulant**  
*Basic Set for Hysteroscopy – operative / atraumatic – outpatient*



Artikelbezeichnung Article description	Stückzahl Quantity	Produkt Product	Bestell-Nr. Ordering number
BARRETT Hakenzange, 180 mm BARRETT Tenaculum Forceps, 180 mm	1		370-506-180
SIMS Uterussonde, 32 cm, cm-Einteilung, graduiert, starr SIMS Uterine Probe, 32 cm, with centimetre scale, graduated, rigid	1		62-501-320
HEGAR Dilator-Satz (8 Stück), doppelendig HEGAR Dilating-Set (8 pcs), double-ended	1		370-420-080
CUSCO Scheidenspekula, 85 x 35 mm CUSCO Vaginal Specula, 85 x 35 mm	1		62-031-002

# Resektoskopie

## *Resectoscopy*



**Resektoskop-Sets mit intermittierender Spülung**  
*Resectoscope sets with intermittent irrigation*

24 – 27 Charr. / Fr.



**Resektoskopenschaft mit starrem Hahn / Resectoscope sheath with fixed stopcock**

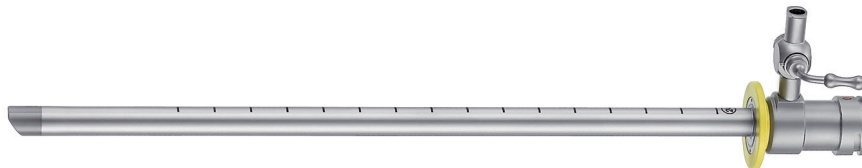

24 Charr. / Fr.	gelb/yellow	ARS010-024-302
27 Charr. / Fr.	schwarz/black	ARS010-027-302

**Standardobturator / Standard Obturator**



24 Charr. / Fr.	gelb/yellow	ARS080-024-302
27 Charr. / Fr.	schwarz/black	ARS080-027-302

**Arbeitselement, passiv schneidend**  
*Working Element, passive cutting action*



ARS102-040-302

**Schlingenelektrode, abgewinkelt, 30° rückwärts**  
*Loop electrode, angled, 30° backwards*



24 Charr. / Fr.

ARS150-024-302B

**Resektoskop-Sets mit Dauerspül-Doppelschaft-System, feststehend**  
*Resectoscope sets with continuous flow double-sheath system, fixed*

26 – 28,5 Charr. / Fr.



Innenschaft / Inner sheath (QUICK LOCK)		Standardobturatoren / Standard Obturators	
24 Charr. / Fr.	ARS020-024-302	ARS080-024-302	
27 Charr. / Fr.	ARS020-027-302	ARS080-027-302	

Außenschaft mit 2 starren Hähnen / Outer sheath with 2 fixed stopcocks (QUICK LOCK)				

Perforation Perforation								
	rundum surrounding	nur oben/unten top/bottom only	rundum gefenstert surrounding slits	nur oben gefenstert slits on top only				
26 Charr. / Fr.	28,5 Charr. / Fr.	26 Charr. / Fr.	26 Charr. / Fr.	26 Charr. / Fr.	26 Charr. / Fr.	26 Charr. / Fr.	26 Charr. / Fr.	26 Charr. / Fr.
gelb/yellow	schwarz/black	gelb/yellow	gelb/yellow	gelb/yellow	gelb/yellow	gelb/yellow	gelb/yellow	gelb/yellow
ARS030-026-302	ARS030-028-302	ARS032-026-302	ARS034-026-302	ARS036-026-302				

Arbeitselement, passiv schneidend Working Element, passive cutting action	Schlingenelektrode, abgewinkelt, 30° rückwärts Loop electrode, angled, 30° backwards
ARS102-040-302	24 Charr. / Fr.
	ARS150-024-302B

**Resektoskop-Sets mit Dauerspül-Doppelschaft-System, drehbar**  
*Resectoscope sets with continuous flow double-sheath system, rotatable*

**26 – 28,5 Charr. / Fr.**



Innenschaft / Inner sheath (QUICK LOCK)		Standardobturator / Standard Obturator
24 Charr. / Fr.	ARS050-024-302	ARS080-024-302
27 Charr. / Fr.	ARS050-027-302	ARS080-027-302

**Außenschaft mit 2 starren Hähnen / Outer sheath with 2 fixed stopcocks (QUICK LOCK)**



Perforation Perforation				
	rundum surrounding	nur oben/unten top/bottom only	rundum gefenstert surrounding slits	nur oben gefenstert slits on top only
26 Charr. / Fr.	28,5 Charr. / Fr.	26 Charr. / Fr.	26 Charr. / Fr.	26 Charr. / Fr.
gelb/yellow	schwarz/black	gelb/yellow	gelb/yellow	gelb/yellow
ARS060-026-302	ARS060-028-302	ARS062-026-302	ARS064-026-302	ARS066-026-302

**Arbeitselement, passiv schneidend**  
**Working Element, passive cutting action**



ARS102-040-302

**Schlingenelektrode, abgewinkelt, 30° rückwärts**  
**Loop electrode, angled, 30° backwards**



24 Charr. / Fr.

ARS150-024-302B

## Obturatoren für Resektoskopschäfte Obturator for Resectoscope sheaths

24 – 28,5 Charr. / Fr.



Charr Fr.	Kennfarbe Colour code	Instr.-Kanal Instr. channel	Bestell.-Nr. Ordering number
		Durchlaß / Charr. Capacity / Fr.	

### Standardobturator / Standard Obturator



24	yellow/gelb		ARS080-024-302
27	schwarz/black		ARS080-027-302

### Beweglicher Obturator / Deflecting Obturator



24	yellow/gelb		ARS082-024-302
27	schwarz/black		ARS082-027-302

### Sichtobturator / Viewing Obturator



24	yellow/gelb		ARS084-024-302
27	schwarz/black		ARS084-027-302

### Sichtobturator mit Instrumentenkanal / Viewing Obturator with instrument channel



24	yellow/gelb	5	ARS086-024-302
27	schwarz/black	7	ARS086-027-302

**Arbeitselemente für Resektoskope**  
*Working Elements for Resectoscopes*

**24 – 28,5 Charr. / Fr.**



**Arbeitselement, passiv schneidend / Working Element, passive cutting action**



Schnitt erfolgt durch Federdruck/Spring-assisted cutting action



geschlossener Griff/closed handle Monopolar

ARS100-040-302



geschlossener Griff/closed handle Bipolar

ARS102-040-302

**Arbeitselement, aktiv schneidend / Working Element, active cutting action**



Schnitt erfolgt gegen Federdruck/Manual cutting action and spring-assisted release



geschlossener Griff/closed handle Monopolar

ARS110-040-302























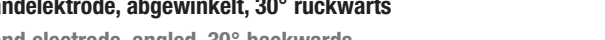

geschlossener Griff/closed handle Bipolar

ARS112-040-302

**Elektroden für Resektoskope, monopolar**  
*Electrodes for Resectoscopes, monopolar*

24 – 28,5 Charr. / Fr.

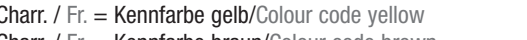

			
<b>Schlingenelektrode abgewinkelt, 30° rückwärts</b> Loop electrode, angled, 30° backwards		<b>Kugelelektrode / Rollerball electrode</b>	
			
24 Charr. / Fr.                      27 Charr. / Fr.		3 mm                                      5 mm	
ARS150-024-302                      ARS150-027-302		24 Charr. / Fr.	
ARS150-024-302                      ARS150-027-302		ARS180-024-302                      ARS182-024-302	
			
<b>Schlingenelektrode, abgewinkelt / Loop electrode, angled</b>		<b>Rollenelektrode, glatt / Roller electrode, smooth</b>	
			
24 Charr. / Fr.                      27 Charr. / Fr.		3 mm                                      5 mm	
ARS152-024-302                      ARS152-027-302		24 Charr. / Fr.	
ARS152-024-302                      ARS152-027-302		ARS184-024-302                      ARS186-024-302	
			
<b>Schlingenelektrode, gerade / Loop electrode, straight</b>		<b>Vaporisationselektrode, glatt / Vaporization electrode, smooth</b>	
			
24 Charr. / Fr.                      27 Charr. / Fr.		3 mm                                      5 mm	
ARS154-024-302                      ARS154-027-302		24 Charr. / Fr.	
ARS154-024-302                      ARS154-027-302		ARS190-024-302                      ARS192-024-302	
			
<b>Messerelektrode, abgewinkelt / Knife electrode, angled</b>		<b>Kegelelektrode, abgewinkelt / Conical electrode, angled</b>	
			
24 Charr. / Fr.		24 Charr. / Fr.	
ARS160-024-302		ARS170-024-302	
			
<b>Bandelektrode, abgewinkelt / Band electrode, angled</b>		<b>Bandelektrode, abgewinkelt, 30° rückwärts</b> Band electrode, angled, 30° backwards	
			
24 Charr. / Fr.*		24 Charr. / Fr.*	
ARS202-024-302		ARS200-024-302	
			
<b>Kürette, scharf (nicht zur Verwendung mit HF-Strom)</b> Curette, sharp (not for use with HF current)		<b>Schutzhülse, rostfreier Stahl</b> Protecting Sleeve, stainless steel	
			
24 Charr. / Fr.*		für die Sterilisation und Aufbewahrung / for sterilization and storage	
ARS220-024-302		AEA030-000-000	

24 Charr. / Fr. = Kennfarbe gelb/Colour code yellow  
27 Charr. / Fr. = Kennfarbe braun/Colour code brown

\* Auf Anfrage.  
Upon request.

### Elektroden für Resektoskope, Bipolar Electrodes for Resectoscopes, Bipolar

24 – 28,5 Charr. / Fr.



<b>Schlingenelektrode abgewinkelt, 30° rückwärts</b> Loop electrode, angled, 30° backwards		<b>Kugelelektrode / Rollerball electrode</b>	
24 Charr. / Fr.	27 Charr. / Fr.	3 mm	5 mm
ARS150-024-302B	ARS150-027-302B	24 Charr. / Fr.	
		ARS180-024-302B	ARS182-024-302B
<b>Schlingenelektrode, abgewinkelt / Loop electrode, angled</b>		<b>Rollenelektrode, glatt / Roller electrode, smooth</b>	
24 Charr. / Fr.	27 Charr. / Fr.	3 mm	5 mm
ARS152-024-302B	ARS152-027-302B	24 Charr. / Fr.	
		ARS184-024-302B	ARS186-024-302B
<b>Schlingenelektrode, gerade / Loop electrode, straight</b>		<b>Vaporisationselektrode, glatt / Vaporization electrode, smooth</b>	
24 Charr. / Fr.	27 Charr. / Fr.	3 mm	5 mm
ARS154-024-302B	ARS154-027-302B	24 Charr. / Fr.	
		ARS190-024-302B	ARS192-024-302B
<b>Messerelektrode, abgewinkelt / Knife electrode, angled</b>		<b>Kegelelektrode, abgewinkelt / Conical electrode, angled</b>	
24 Charr. / Fr.		24 Charr. / Fr.	
ARS160-024-302B		ARS170-024-302B	
<b>Bandelektrode, abgewinkelt / Band electrode, angled</b>		<b>Bandelektrode, abgewinkelt, 30° rückwärts</b> Band electrode, angled, 30° backwards	
24 Charr. / Fr.*		24 Charr. / Fr.*	
ARS202-024-302B		ARS200-024-302B	
<b>Kürette, scharf (nicht zur Verwendung mit HF-Strom)</b> Curette, sharp (not for use with HF current)		<b>Schutzhülse, rostfreier Stahl</b> Protecting Sleeve, stainless steel	
24 Charr. / Fr.*		für die Sterilisation und Aufbewahrung / for sterilization and storage	
ARS220-024-302B		AEA030-000-000	







24 Charr. / Fr. = Kennfarbe gelb und Blau/Colour code yellow and Blue  
 27 Charr. / Fr. = Kennfarbe braun/Colour code brown

\* Auf Anfrage.  
 Upon request.

**Optische Instrumente**  
*Optical Instruments*

19 – 25 Charr. / Fr.



<p><b>Probeexzisionszange, doppelbeweglich, für Endoskope 0° / 12° / (30°)</b> <b>Biopsy forceps, double action, for endoscopes 0° / 12° / (30°)</b></p>	<p><b>Probeexzisionszange, doppelbeweglich, für Endoskope 12° / 30°</b> <b>Biopsy forceps, double action, for endoscopes 12° / 30°</b></p>
	
<p>ACU152-040-302</p>	<p>ACU154-040-302</p>
<p><b>Fasszange, doppelbeweglich, für Endoskope 0° / 12° / (30°)</b> <b>Grasping forceps, double action, for endoscopes 0° / 12° / (30°)</b></p>	<p><b>Probeexzisionszange, doppelbeweglich, für Endoskop 70°</b> <b>Biopsy forceps, double action, for endoscope 70°</b></p>
	
<p>ACU170-040-302</p>	<p>ACU156-040-302</p>
<p><b>Probeexzisionszange, doppelbeweglich, durchschneidend, für Endoskope 0° / 12° / (30°)</b> <b>Biopsy forceps, double action, through cutting, for endoscopes 0° / 12° / (30°)</b></p>	<p><b>Schere, doppelbeweglich, für Endoskope 0° / 12° / (30°)</b> <b>Scissors, double action, for endoscopes 0° / 12° / (30°)</b></p>
	
<p>ACU160-040-302</p>	<p>ACU180-040-302</p>
<p><b>Adapter für optische Instrumente zur Verwendung mit Resektoskop-Schäften (24 – 27 Charr.)</b> <b>Adaptor for optical instruments to be used with resectoscope sheaths (24 – 27 Fr.)</b></p>	
	
<p>ACU150-040-302</p>	

Weitere Modelle auf Anfrage.  
Further models upon request.

**Kleinkalibriges Resektoskop-Set mit intermittierender Spülung**  
*Slim calibre Resectoscope set with intermittent irrigation*

19 Charr. / Fr.



**Resektoskopschaft mit starrem Hahn / Resectoscope sheath with fixed stopcock**

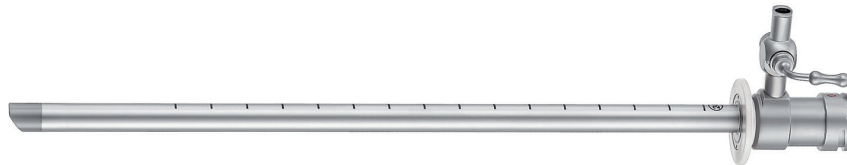

19 Charr. / Fr.

weiß/white

ARS010-019-302

**Standardobturator / Standard Obturator**



19 Charr. / Fr.

weiß/white

ARS080-019-302

**Arbeitselement, passiv schneidend**  
*Working Element, passive cutting action*

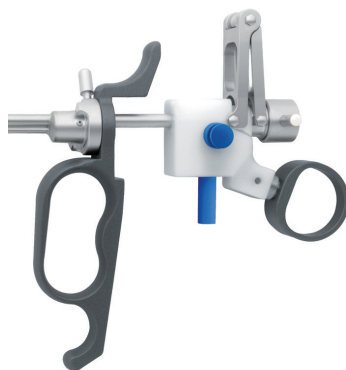

ARS102-029-302

**Schlingenelektrode, abgewinkelt, 30° rückwärts**  
*Loop electrode, angled, 30° backwards*



19 Charr. / Fr.

weiß/white

ARS150-019-302

Auch passend für 2,7 mm Endoskope.  
Also suitable for 2,7 mm Endoscopes.

**Kleinkalibriges Resektoskop-Set mit Dauerspül-Doppelschaft-System, drehbar**  
*Slim calibre Resectoscope set with continuous flow double-sheath system, rotatable*

22 Charr. / Fr.



Innenschaft / Inner Sheath (QUICK LOCK)		Standardobturator / Standard Obturator	
19 Charr. / Fr.		19 Charr. / Fr.	
ARS050-019-302		ARS080-019-302	
Außenschaft mit 2 starren Hähnen / Outer sheath with 2 fixed stopcocks (QUICK LOCK)			
Perforation Perforation			
	rundum surrounding		
22 Charr. / Fr.			
weiß/white			
ARS060-022-302			
Arbeitselement, passiv schneidend Working Element, passive cutting action		Schlingenelektrode, abgewinkelt, 30° rückwärts Loop electrode, angled, 30° backwards	
ARS102-029-302		19 Charr. / Fr.	
		weiß/white	
		ARS150-019-302	

Auch passend für 2,7 mm Endoskope.  
Also suitable for 2,7 mm Endoscopes.

**Obturatoren für kleinkalibrige Resektoskopschäfte**  
*Obturator for slim calibre Resectoscope sheaths*

**19 – 22 Charr. / Fr.**



Charr. Fr.	Kennfarbe Colour code	Instr.-Kanal Instr. channel	Bestell-Nr. Ordering number
		Durchlass / Charr. Capacity / Fr.	

**Standardobturator / Standard Obturator**



19	weiß/white		ARS080-019-302
----	------------	--	----------------

**Sichtobturator / Viewing Obturator**



19	weiß/white		ARS084-019-302
----	------------	--	----------------

**Arbeitselemente für kleinkalibrige Resektoskope**  
*Working Elements for slim calibre Resectoscopes*

19 – 22 Charr. / Fr.



**Arbeitselement, passiv schneidend / Working Element, passive cutting action**



Schnitt erfolgt durch Federdruck/Spring-assisted cutting action



geschlossener Griff/closed handle Monopolar

ARS100-029-302



geschlossener Griff/closed handle Bipolar

ARS102-029-302

**Arbeitselement, aktiv schneidend / Working Element, active cutting action**



Schnitt erfolgt gegen Federdruck/Manual cutting action and spring-assisted release



geschlossener Griff/closed handle Monopolar

ARS110-029-302









geschlossener Griff/closed handle Bipolar

ARS112-029-302

**Elektroden für kleinkalibrige Resektoskope, monopolar**  
*Electrodes for slim calibre Resectoscopes, monopolar*

19 – 22 Charr. / Fr.



<b>Schlingenelektrode, abgewinkelt, 30° rückwärts</b> <i>Loop electrode, angled, 30° backwards</i>	<b>Kugelelektrode, 3 mm / Rollerball electrode, 3 mm</b>
	
19 Charr. / Fr.	19 Charr. / Fr.
ARS150-019-302	ARS180-019-302
<b>Schlingenelektrode, gerade / Loop electrode, straight</b>	<b>Rollenelektrode, glatt, 3 mm / Roller electrode, smooth, 3 mm</b>
	
19 Charr. / Fr.	19 Charr. / Fr.
ARS154-019-302	ARS184-019-302
<b>Messerelektrode, abgewinkelt / Knife electrode, angled</b>	<b>Schutzhülse, rostfreier Stahl / Protecting Sleeve, stainless steel</b>
	
19 Charr. / Fr.	für die Sterilisation und Aufbewahrung/for sterilization and storage
ARS160-019-302	AEA030-000-000

19 Charr. / Fr. = Kennfarbe weiß/Colour code white

**Resektoskop-Sets mit Dauerspül-Doppelschaft-System, drehbar**  
*Resectoscope sets with continuous flow double-sheath system, rotatable*

17.5 – 18.5 Charr. / Fr.



Innenschaft / Inner sheath (QUICK LOCK)		Standardobturator / Standard Obturator
17.5 Charr. / Fr.	ARS050-017-302	ARS080-017-302

**Außenschaft mit 2 starren Hähnen / Outer sheath with 2 fixed stopcocks (QUICK LOCK)**









Perforation Perforation				
	rundum surrounding	nur oben/unten top/bottom only	rundum gefenstert surrounding slits	nur oben gefenstert slits on top only
18.5 Charr. / Fr.		18.5 Charr. / Fr.	18.5 Charr. / Fr.	18.5 Charr. / Fr.
grün/green		grün/green	grün/green	grün/green
ARS060-018-302		ARS062-018-302	ARS064-018-302	ARS066-018-302

Bipolar Arbeitselement, passiv schneidend Bipolar Working Element, passive cutting action	Schlingenelektrode, abgewinkelt, 30° rückwärts Loop electrode, angled, 30° backwards
	17.5 Charr. / Fr.
ARS102-017-302	ARS150-017-302

**Elektroden für kleinkalibrige Resektoskope, Bipolar**  
*Electrodes for slim calibre Resectoscopes, Bipolar*

17.5 – 18.5 Charr. / Fr.



<b>Schlingenelektrode, abgewinkelt, 30° rückwärts</b> <i>Loop electrode, angled, 30° backwards</i>	<b>Kugelelektrode, 3 mm / Rollerball electrode, 3 mm</b>
	
17.5 Charr. / Fr.	17.5 Charr. / Fr.
<b>ARS150-017-302</b>	<b>ARS180-017-302</b>
<b>Schlingenelektrode, gerade / Loop electrode, straight</b>	<b>Rollenelektrode, glatt, 3 mm / Roller electrode, smooth, 3 mm</b>
	
17.5 Charr. / Fr.	17.5 Charr. / Fr.
<b>ARS154-017-302</b>	<b>ARS184-017-302</b>
<b>Messerelektrode, abgewinkelt / Knife electrode, angled</b>	<b>Schutzhülse, rostfreier Stahl / Protecting Sleeve, stainless steel</b>
	
17.5 Charr. / Fr.	für die Sterilisation und Aufbewahrung/for sterilization and storage
<b>ARS160-017-302</b>	<b>AEA030-000-000</b>

19 Charr. / Fr. = Kennfarbe weiß/Colour code white

**Evakuator und Blasenspritzen zur Adaption an Resektoskopschäfte**  
*Evacuator and Bladder Syringes for adaption to Resectoscope sheaths*

**Evakuator / Evacuator**



	Bestell-Nr. Ordering number
komplett mit Schaftanschluss und Verriegelung complete with sheath connection and locking device	AEI100-000-000
Glasbehälter, alleine/Glass bulb, only	AEI104-000-000
Gummiball, alleine/Rubber bulb, only	AEI106-000-000
<b>Schaftanschluss mit Verriegelung, alleine / Sheath connection with locking device, only</b>	<b>AEI110-000-000</b>



<b>Schaftanschluss mit Konus, alleine / Sheath connection with cone, only</b>	<b>AEI112-000-000</b>
---	-----------------------



**Blasenspritze mit Adapter / Bladder Syringe with adaptor**















50 ml	418-928-050
75 ml	418-928-075
100 ml	418-928-100
150 ml	418-928-150
200 ml	418-928-200

**Basis-Set für Hysteroskopie (HF), für intrauterine HF-Chirurgie, operativ**  
**Basic Set for Hysteroscopy (HF), for intrauterine HF surgery, operative**

26 Charr. / Fr.



Artikelbezeichnung Article description	Stückzahl Quantity	Produkt Product	Bestell-Nr. Ordering number
Set, komplett Set, complete			ASE260-110-110
Dauerspül-Außenschaft, drehbar, 26 Charr. Continuous flow outer sheath, rotatable, 26 Fr.	1		ARS060-026-302
Innenschaft, für Dauerspül-Außenschaft 26 Charr., drehbar, 24 Charr. Inner sheath, for continuous flow outer sheath 26 Fr., rotatable, 24 Fr.	1		ARS050-024-302
Standardobturator, 24 Charr. Standard obturator, 24 Fr.	1		ARS080-024-302
Arbeitselement, passiv schneidend Working element, passive cutting action	1		ARS100-040-302
Schlingenelektrode, abgewinkelt, 30° rückwärts, 24 Charr. Cutting loop electrode, angled, 30° backwards, 24 Fr.	1		ARS150-024-302
Schlingenelektrode, gerade, 24 Charr. Loop electrode, straight, 24 Fr.	1		ARS154-024-302
Bandeletrode, abgewinkelt, 24 Charr. Band electrode, angled, 24 Fr.	1		ARS202-024-302
Rollenelektrode, glatt, 3,0 mm, 24 Charr. Roller electrode, smooth, 3,0 mm, 24 Fr.	1		ARS184-024-302
Kugelelektrode, 3,0 mm, 24 Charr. Rollerball electrode, 3,0 mm, 24 Fr.	1		ARS180-024-302
Messerelektrode, abgewinkelt, 24 Charr. Knife electrode, angled, 24 Fr.	1		ARS160-024-302
Schutzhülse für Elektroden, rostfreier Stahl Protecting sleeve for electrodes, stainless steel	1		AEA030-000-000
HF-Kabel, monopolar, Martin, 4,0 mm, 3 m lang HF cable, monopolar, Martin, 4,0 mm, 3 m long	1		AHC012-040-300

\*Passende Endoskope finden Sie in Unserem separaten Endoskopie Flyer.

\*Suitable Endoscopes can be found in our Endoscopy flyer.

**Basis-Set für Hysteroskopie (HF), für intrauterine HF-Chirurgie, operativ**  
**Basic Set for Hysteroscopy (HF), for intrauterine HF surgery, operative**

26 Charr. / Fr.













Artikelbezeichnung Article description	Stückzahl Quantity	Produkt Product	Bestell-Nr. Ordering number
Optische Probeexcisionszange für Cysto-Urethroskope (12°/30°); doppelbeweglich Optical biopsy forceps for cysto-urethrosopes (12°/30°); double action	1		ACU154-040-302
Optische Schere für Cysto-Urethroskope (0°/12°); doppelbeweglich Optical scissors for cysto-urethrosopes (0°/12°); double action	1		ACU180-040-302
Optische Fasszange für Cysto-Urethroskope (0°/12°); doppelbeweglich Optical grasping forceps for cysto-urethrosopes (0°/12°); double action	1		ACU170-040-302
Adapter für den Einsatz optischer Instrumente mit Resektoskopschäften Adaptor for use of optical instruments with resectoscope sheaths	1		ACU150-040-302
Endoskopbrücke mit 1 x 5 Charr. Instrumentenkanal Endoscope bridge with 1 x 5 Fr. instrument channel	1		AUT090-040-302
Flexible Schere, 400 mm, 5 Charr. Flexible scissors, 400 mm, 5 Fr.	1		AFF201-216-040
Flexible Probeexcisions- und Fasszange, 400 mm, 5 Charr. Flexible biopsy and grasping forceps, 400 mm, 5 Fr.	1		AFF203-216-040
Flexible Fremdkörperzange, Alligatormaul, 400 mm, 5 Charr. Flexible foreign body forceps, Alligator jaw, 400 mm, 5 Fr.	1		AFF204-216-040
Endoskopiesiebkorb für 1 Endoskop, 460 x 80 x 55 mm Endoscope Wire Basket f. 1 endoscope, 460 x 80 x 55 mm	2		74-600-040
BARRETT Hakenzange, 180 mm BARRETT Tenaculum Forceps, 180 mm	1		370-506-180
SIMS Uterussonde, 32 cm, cm-Einteilung, graduert, starr SIMS Uterine Probe, 32 cm, with centimetre scale, graduated, rigid	1		62-501-320
HEGAR Dilatator-Satz (8 Stück), doppelendig HEGAR Dilating-Set (8 pcs), double-ended	1		370-420-080
CUSCO Scheidenspekula, 85 x 35 mm CUSCO Vaginal Specula, 85 x 35 mm	1		62-031-002

### Basis-Set für Hysteroskopie (HF), und intrauterine HF-Chirurgie, operativ

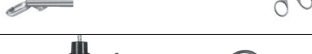
*Basic Set for Hysteroscopy (HF), and intrauterine HF surgery, operative*

22 Charr. / Fr.



Artikelbezeichnung Article description	Stückzahl Quantity	Produkt Product	Bestell-Nr. Ordering number
Set, komplett Set, complete			ASE260-110-140
OP-Untersuchungseinsatz, 5 Charr. Instrumenten-Kanal, 1 Spülhahn OP Examination insert, 5 Fr. instr. channel, 1x stopcock	1		AHY260-029-302
Außenschaft für Dauerspülung, 1 Hahn, D = 6,0 x 4,2 mm, NL = 190 mm, tropfenförmig Outer sheath for continuous-flow, 1 stopcock d = 6,0 x 4,2 mm, WL = 190 mm drop-shaped	1		AHY261-029-302
Flexible Schere, 340 mm, 5 Charr. Flexible scissors, 340 mm, 5 Fr.	1		AFF201-216-034
Flexible Probeexcisions- und Fasszange, 340 mm, 5 Charr. Flexible biopsy and grasping forceps, 340 mm, 5 Fr.	1		AFF203-216-034
Flexible Fremdkörperzange, Alligatormaul, 340 mm, 5 Charr. Flexible foreign body forceps, Alligator jaw, 340 mm, 5 Fr.	1		AFF204-216-034
Flexible Probeexcisionszange, 340 mm, 5 Charr. Flexible biopsy forceps, 340 mm, 5 Fr.	1		AFF200-216-034
Handgriff allein, mit HF Anschluss für Diathermie Schlinge Handle only, with HF plug for diathermy loop	1		AHI110-000-000
Diathermieschlinge allein, mit Teflontubus 5 Ch., 5 m lang Diathermy loop only, with Teflon tubus, 5 Fr., 5 m long	1		AHI110-416-050
Flexible Nadelelektrode, 5 Charr. NL = 450 mm Flexible needle electrode, 5 Fr., WL = 450 mm	1		AHI010-416-045
Flexible Knopfelektrode, 5 Charr. NL = 450 mm Flexible button electrode, 5 Fr., WL = 450 mm	1		AHI020-416-045
HF-Kabel, monopolar, Martin, 4,0 mm, 3 m lang HF Cable, monopolar, Martin, 4,0 mm, 3 m long	1		AHC012-040-300

\*Passende Endoskope finden Sie in Unserem separaten Endoskopie Flyer .













\*Suitable Endoscopes can be found in our Endoscopy flyer.

### Basis-Set für Hysteroskopie (HF), und intrauterine HF-Chirurgie, operativ

Basic Set for Hysteroscopy (HF), and intrauterine HF surgery, operative

22 Charr. / Fr.





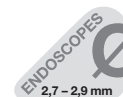

Artikelbezeichnung Article description	Stückzahl Quantity	Produkt Product	Bestell-Nr. Ordering number
Dauerspül-Außenschaft, drehbar, 22 Charr. Continuous flow outer sheath, rotatable, 22 Fr.	1		ARS060-022-302
Innenschaft, 19 Charr., für Dauerspül-Außenschaft, drehbar, 22 Charr. Inner sheath, 19 Fr., for continuous flow outer sheath, rotatable, 22 Fr.	1		ARS050-019-302
Standardobturator, 19 Charr. Standard obturator, 19 Fr.	1		ARS080-019-302
Arbeitselement, passiv schneidend Working element, passive cutting action	1		ARS100-029-302
Schlingenelektrode, abgewinkelt, 30° rückwärts, 19 Charr. Cutting loop electrode, angled, 30° backwards, 19 Fr.	1		ARS150-019-302
Schlingenelektrode, gerade, 19 Charr. Cutting loop electrode, straight, 19 Fr.	1		ARS154-019-302
Kugelelektrode, D = 3,0 mm, 19 Charr. Rollerball electrode, d = 3,0 mm, 19 Fr.	1		ARS180-019-302
Rollenelektrode, D = 3,0 mm, 19 Charr. Roller electrode, d = 3,0 mm, 19 Fr.	1		ARS184-019-302
Messerelektrode, abgewinkelt, 19 Charr. Knife electrode, angled, 19 Fr.	1		ARS160-019-302
Schutzhülse für Elektroden, rostfreier Stahl Protecting sleeve for electrodes, stainless steel	1		AEA030-000-000
HF-Kabel, monopolar, Martin, 4,0 mm, 3 m lang HF cable, monopolar, Martin, 4,0 mm, 3 m long	1		AHC012-040-300
Endoskopbrücke mit 1 x 5 Charr. Instrumentenkanal Endoscope bridge with 1 x 5 Fr. instrument channel	1		AUT090-029-302
Endoskopiesiebkorb für 1 Endoskop, 460 x 80 x 55 mm Endoscope Wire Basket f. 1 endoscope, 460 x 80 x 55 mm	1		74-600-040

**Basis-Set für Hysteroskopie (HF), und intrauterine HF-Chirurgie, operativ**  
*Basic Set for Hysteroscopy (HF), and intrauterine HF surgery, operative*

22 Charr. / Fr.



Artikelbezeichnung Article description	Stückzahl Quantity	Produkt Product	Bestell-Nr. Ordering number
BARRETT Hakenzange, 180 mm BARRETT Tenaculum Forceps, 180 mm	1		370-506-180
SIMS Uterussonde, 32 cm, cm-Einteilung, graduiert, starr SIMS Uterine Probe, 32 cm, with centimetre scale, graduated, rigid	1		62-501-320
HEGAR Dilatator-Satz (8 Stück), doppelendig HEGAR Dilating-Set (8 pcs), double-ended	1		370-420-080
CUSCO Scheidenspekula, 85 x 35 mm CUSCO Vaginal Specula, 85 x 35 mm	1		62-031-002

# Laseranwendungen

## *Laser Applications*



### Laser-Resektoskop-Sets mit Dauerspül-Doppelschaft-System, feststehend

*Laser Resectoscope sets with continuous flow double-sheath system, fixed*

26 – 28,5 Charr. / Fr.

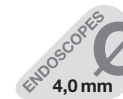

#### Innenschaft / Inner sheath (QUICK LOCK)



#### Standardobturator / Standard Obturator



24 Charr. / Fr.	ARS020-024-302	ARS080-024-302
27 Charr. / Fr.	ARS020-027-302	ARS080-027-302

#### Außenschaft mit 2 starren Hähnen / Outer sheath with 2 fixed stopcocks (QUICK LOCK)



Perforation Perforation	rundum surrounding		nur oben/unten top/bottom only	rundum gefenstert surrounding slits	nur oben gefenstert slits on top only
	26 Charr. / Fr.	28,5 Charr. / Fr.	26 Charr. / Fr.	26 Charr. / Fr.	26 Charr. / Fr.
gelb/yellow	schwarz/black	gelb/yellow	gelb/yellow	gelb/yellow	gelb/yellow
ARS030-026-302	ARS030-028-302	ARS032-026-302	ARS034-026-302	ARS036-026-302	

#### Arbeitselement, passiv schneidend, geschlossener Griff, Führungskanal für Lasersonden

*Working Element, passive cutting action, closed handle, Guiding channel for laser probes*

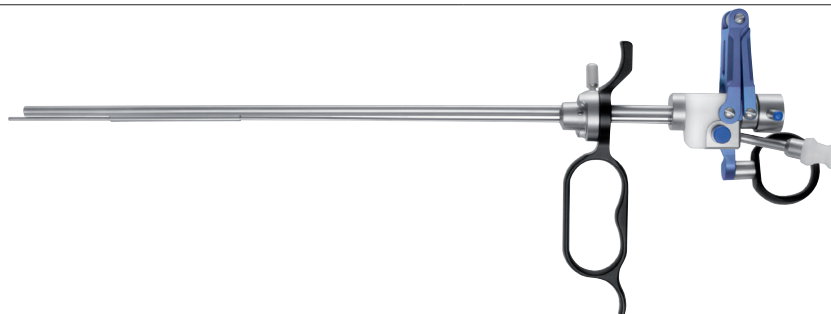

ARS300-040-302	für Lasersonden bis Ø 0,8 mm / for laser probes up to Ø 0.8 mm
ARS300-140-302	für Lasersonden bis Ø 1,2 mm / for laser probes up to Ø 1.2 mm

**Laser-Resektoskop-Sets mit Dauerspül-Doppelschaft-System, drehbar**  
*Laser Resectoscope sets with continuous flow double-sheath system, rotatable*

26 – 28,5 Charr. / Fr.



Innenschaft / Inner sheath (QUICK LOCK)		Standardobturator / Standard Obturator
24 Charr. / Fr.	ARS050-024-302	ARS080-024-302
27 Charr. / Fr.	ARS050-027-302	ARS080-027-302

**Außenschaft mit 2 starren Hähnen / Outer sheath with 2 fixed stopcocks (QUICK LOCK)**



Perforation Perforation				
	rundum surrounding	nur oben/unten top/bottom only	rundum gefenstert surrounding slits	nur oben gefenstert slits on top only
26 Charr. / Fr.	28,5 Charr. / Fr.	26 Charr. / Fr.	26 Charr. / Fr.	26 Charr. / Fr.
gelb/yellow	schwarz/black	gelb/yellow	gelb/yellow	gelb/yellow
ARS060-026-302	ARS060-028-302	ARS062-026-302	ARS064-026-302	ARS066-026-302

**Arbeitselement, passiv schneidend, geschlossener Griff, Führungskanal für Lasersonden**

*Working Element, passive cutting action, closed handle, Guiding channel for laser probes*



ARS300-040-302	für Lasersonden bis Ø 0,8 mm/for laser probes up to Ø 0.8 mm
ARS300-140-302	für Lasersonden bis Ø 1,2 mm/for laser probes up to Ø 1.2 mm

**Arbeitselemente und Endoskopbrücke für Resektoskope**  
*Working Elements and Endoscope Bridge for Resectoscopes*

24 – 28,5 Charr. / Fr.



**Arbeitselemente, passiv schneidend / Working Elements, passive cutting action**



Schnitt erfolgt durch Federdruck/Spring-assisted cutting action



geschlossener Griff/closed handle Monopolar

ARS100-040-302



geschlossener Griff/closed handle Bipolar

ARS102-040-302

**Endoskopbrücke / Endoscope Bridge**

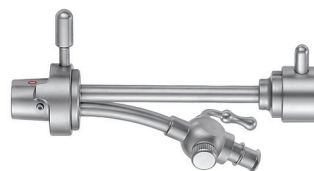

mit 1 x 5 Charr. Instrumentenkanal

with 1 x 5 Fr. instrument channel

AUT090-040-302

\* für Elektroden und Küretten siehe "Resektoskopie" – „Elektroden für Resektoskope, monopolar“.  
for Electrodes and Curettes please refer to „Resectoscopy“ – „Electrodes for Resectoscopes, monopolar“.

**Optische Gewebestanze für Resektoskopaußenschäfte**  
*Optical Tissue Punch for Resectoscope outer sheaths*

26 – 28,5 Charr. / Fr.



**Optische Gewebestanze / Optical Tissue Punch**

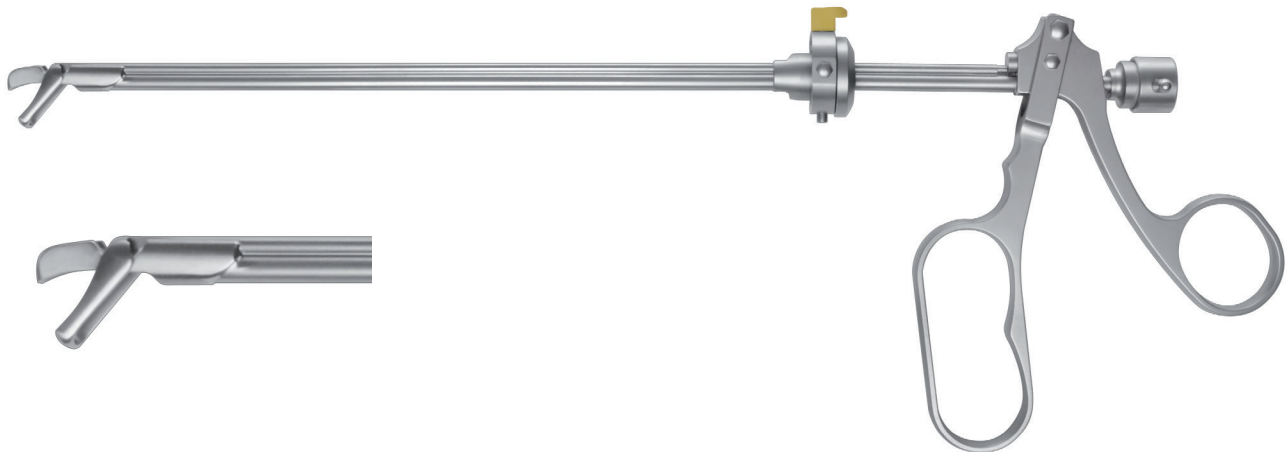

	Bestell-Nr. Ordering number
für Endoskope, 12°, 30° for endoscopes, 12°, 30°	ARS330-040-302

## **Instrumente**

## *Instruments*



## Metallkatheter und Einführungsinstrumente Metal Catheters and Introducing Instruments

### Metallkatheter für Frauen / Metal catheters for women



Charr. / Fr.	Bestell-Nr. / Ordering number
8	60-441-008
10	60-441-010
12	60-441-012
14	60-441-014
16	60-441-016
18	60-441-018
20	60-441-020
22	60-441-022
24	60-441-024

### GUYON Katheter-Einführungsinstrumente / GUYON Catheter Introducing Instruments

Länge / Length	Bestell-Nr. / Ordering number
gerade/straight	
	
39 cm	366-180-390

gebogen/curved	
	
35 cm	366-181-350

**Intrauterinsonde nach COHEN**  
*Intrauterine Probe by COHEN*

**Intrauterinsonde / Intrauterine Probe**



	Bestell-Nr. Ordering number
komplett mit 2 Portioadaptern (gr./kl.) Fixieren, Elevieren, Pertubation von Gebärmutter/Eileiter complete with 2 Portio Adaptors (lg./sm.) fixation, elevation, pertubation of uterus/fallopian tubes	92-036-000
Intrauterinsonde, allein/Intrauterine Probe, only	92-036-010
Portio-Adapter, klein/Portio Adaptor, small	92-036-020
Portio-Adapter, groß/Portio Adaptor, large	92-036-030

**Uterusmanipulator**  
*Uterine Manipulator*

**Uterusmanipulator / Uterine Manipulator**

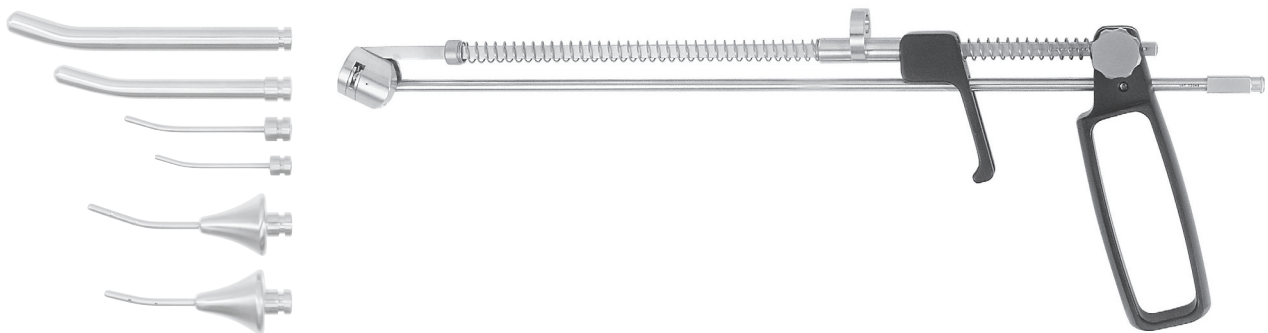

	Nutzlänge Working length	Durchmesser Diameter	Bestell-Nr. Ordering number
komplett mit 6 Adaptern Fixieren, Elevieren, Pertubation von Gebärmutter/Eileiter complete with 6 Adaptors fixation, elevation, pertubation of uterus/fallopian tubes			92-036-100
Uterusmanipulator, allein/Uterine Manipulator, only			92-036-110

**Adapter (Obturator) / Adaptor (Obturator)**

	100 mm	10,0 mm	92-036-120
	80 mm	8,0 mm	92-036-121
	55 mm	3,0 mm	92-036-122
	45 mm	3,0 mm	92-036-123

**Adapter mit Konus / Adaptor with Cone**

 langer Dorn/large thorn	70 mm	3,3 mm	92-036-124
 kurzer Dorn/short thorn	60 mm	3,3 mm	92-036-125

**Tenakulumzangen**  
*Tenaculum forceps*

**Tenakulumzange BARRETT / Tenaculum forceps BARRETT**

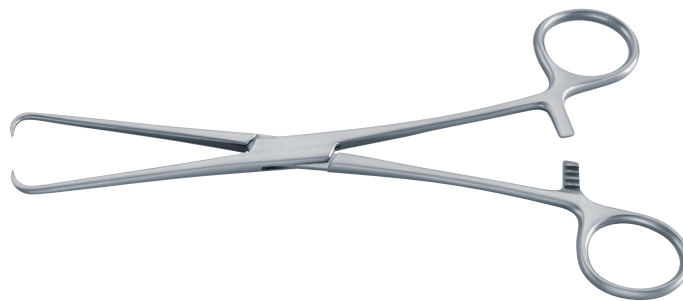

	Nutzlänge Working length	Bestell-Nr. Ordering number
	180 mm	370-506-180

**Tenakulumzange POZZI / Tenaculum forceps POZZI**

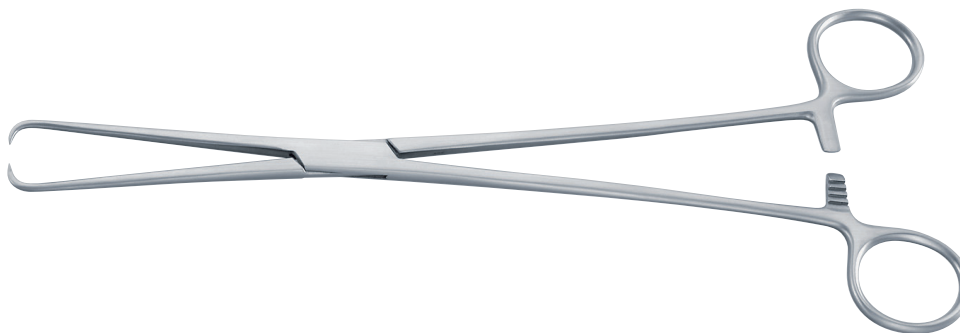

	Nutzlänge Working length	Bestell-Nr. Ordering number
	255 mm	370-502-250

**Uterus Sonden und Dilatatorens-Sets**  
*Uterine Probes and Dilator Sets*

**Uterussonde MARTIN / Uterine Probe MARTIN**



	Nutzlänge Working length	Bestell-Nr. Ordering number
starr/rigid	320 mm	62-507-320
biegsam/malleable		62-509-320

**Uterussonde SIMS / Uterine Probe SIMS**



	Nutzlänge Working length	Bestell-Nr. Ordering number
starr/rigid	320 mm	62-501-320
biegsam/malleable		62-503-320

**Uterus Dilatatorens-Set HEGAR, doppelendig / Uterine Dilator Set HEGAR, double ended**



	Durchmesser Diameter	Bestell-Nr. Ordering number
Set bestehend aus 8 Dilatatoren/Set consisting of 8 dilators	3,0/4,0 mm – 17,0/18,0 mm	370-420-080
Set bestehend aus 13 Dilatatoren/Set consisting of 13 dilators	1,0/2,0 mm – 25,0/26,0 mm	370-420-130

**Flexible IUD-Fasszange**  
*Flexible IUD Grasping Forceps*

IUD-Fasszange\*, flexibel / IUD Grasping Forceps\*, flexible

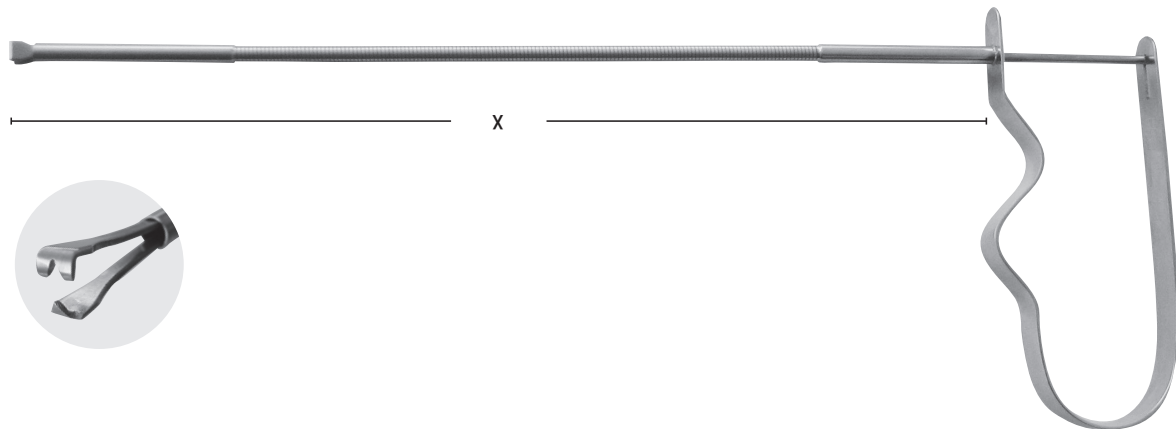

Nutzlänge Working length	Durchmesser Diameter	Bestell-Nr. Ordering number
x = 205 mm	4,0 mm	370-552-300

\* Zange zum Entfernen der Spirale  
Forceps for removal of I.U.D.

**Portio-Adapter**  
*Portio Adaptors*

Portio-Adapter / Portio Adaptor



für Schäfte bis Ø 8,5 mm for Sheaths up to Ø 8,5 mm	Bestell-Nr. Ordering number
Saugglocke, klein/Suction cap, small	92-750-000
Saugglocke, groß/Suction cap, large	92-750-002

**Endometrium-Biopsieküretten NOVAK und Sekretlöffel GUTTMANN**  
*Endometrium Biopsy curettes NOVAK and Secretion Spoon GUTTMANN*

**Endometrium-Biopsiekürette NOVAK / Endometrium Biopsy Curette NOVAK**



Nutzlänge Working length	Durchmesser Diameter	Bestell-Nr. Ordering number
235 mm	1,0 mm	370-588-010
	2,0 mm	370-588-020
	3,0 mm	370-588-030
	4,0 mm	370-588-040

**Sekretlöffel GUTTMANN / Secretion Spoon GUTTMANN**



	Nutzlänge Working length	Bestell-Nr. Ordering number
	265 mm	366-176-260

**Endospekulas KOGAN**  
*Endo Speculae KOGAN*

**Endospekula KOGAN / Endo Specula KOGAN**

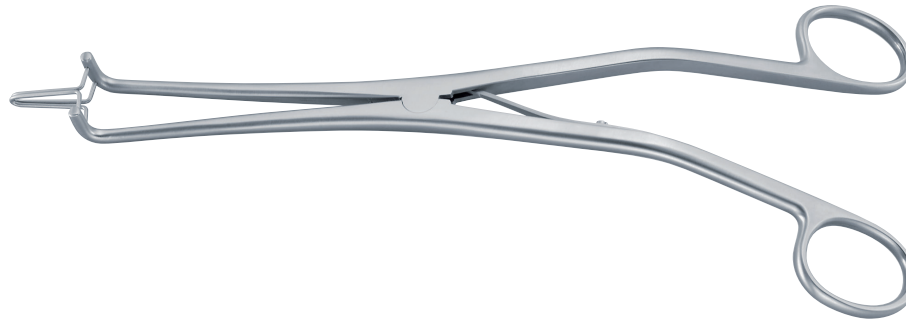

	Nutzlänge Working length	Bestell-Nr. Ordering number
	240 mm	432-377-240

**Endospekula KOGAN, mit Skalensperre und Stellschraube / Endo Specula KOGAN, with scale-ratchet and fixation screw**

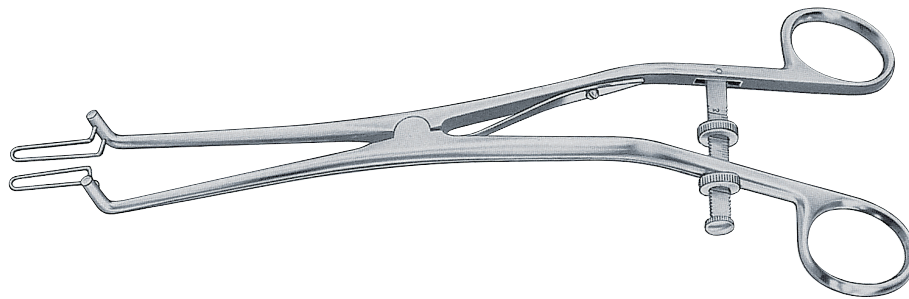

	240 mm	370-356-240
--	--------	-------------

**Endospekula KOGAN MODIF, mit Skalensperre / Endo Specula KOGAN MODIF, with scale-ratchet**



x = 2 mm, y = 4 mm	280 mm	370-362-240
x = 4 mm, y = 8 mm		370-362-480

**Scheidenspekulas**  
*Vaginal Speculae*

**Scheidenspekula CUSCO / Vaginal specula CUSCO**



Nutzlänge Working length	Bestell-Nr. Ordering number	Nutzlänge Working length	Bestell-Nr. Ordering number
75 mm x 32 mm	62-031-001	75 mm x 32 mm	62-041-001
85 mm x 35 mm	62-031-002	85 mm x 35 mm	62-041-002
100 mm x 35 mm	62-031-003	100 mm x 37 mm	62-041-003
175 mm x 17 mm *	62-021-000 *		

\*für Jungfrauen  
for virgins

## Geräte

## *Equipment*

**\*Weitere Geräte finden Sie in unserem separaten Flyer „Endoscopy Systems“.**

*\*For further Systems please refer to our flyer „Endoscopy Systems“.*



**Hysteroskopische Rollen-Spülpumpe (peristaltisch)**  
*Hysteroscopic Roller Irrigation Pump (peristaltic)*



**Bestell-Nr. / Ordering number:**

SIP

A medical fluid pump designed to deliver fluid under a given pressure to an operative field  
The device dedicated to arthroscopic, hysteroscopic and urologic surgeries.  
Controlled by a console or a remote control.

**STRENGTHS**

- Minimally invasive method of delivering fluid to an operative field
- Precise calibration of the measuring system through LEVEL function
- FLUSH function for an efficient rinsing of an operating area
- Non-volatile memory of recent settings
- Three working modes of the Universal Fluid Pump
- Used with disposable and day-use tubings.
- Acoustic and visual signals ensuring correct tubing installation
- Remote controller (optional)
- Big and clear display, intuitive menu
- Esthetic and modern design

**FEATURES**

Universal Fluid Pump provides all the three working modes

Speciality	Arthroscopy	Urology	Hysteroscopy
Pressure	10-150 mmHg	10-150 mmHg	10-150 mmHg
Flow	0,1-2,0 l/min	0,1-1,0 l/min	0,1-0,5 l/min

**Merkmale / Features:**

Weight	7,6 kg
External dimensions	D: 306 mm x W: 330 mm x H: 120 mm
Supply voltage	100-240V AC
Power frequency	50/60 Hz
Class of protection	Applied part - type BF
Casing safety standard	IP X1
Ambient temperature	During operation: +10°C to +40°C
Max. relative humidity	During storage and transport: -20°C to +45°C
CE Standard	operation: 70% During storage and transport: 70%EN60601-1; EN60601-1-2

**TUBING FOR FLUID PUMP**

Tubing sets for Endoscopy Fluid Pumps. Designed in the way to make it easy for medical staff to prepare a pump for surgery. Two options available: single-use or day-use tubing sets (as the economical solution).

**Single-Use Tubing Set (SUTS)**

Installed directly to the pump control unit to an endoscopy sheath. Complete tubing set, changed after each procedure.



**Economic-use tubings sets:**

**1. DAY-USE PUMP PART (DUP)**

Installed directly to the pump's; Connected to a Single-Use Patient Part (SUPP).

Daily Use Pump Part stays installed for one Day of procedures; no need of changing a fluid bag after each surgery.



**2. SINGLE-USE PATIENT PART (SUP)**

Installed directly to the Day-Use Pump Part (DUPP) and to the endoscopy sheath.



**FLUID PUMP REMOTE CONTROL**

Remote Control dedicated to **EMOS** Endoscopy Fluid Pump.

It makes it possible to control the fluid flow and pressure without staying close to the control unit panel. Made from an esthetic and solid stuff.



## COMBINATION LED 50-HD series

- Multifunctional system
- Camera and Lightsource
- Recording option
- Full HD resolution
- Multilingual menu

Item Number: CUCOMPE



Item Number: CUCOMP

## COMBINATION LED 50-HD series

### Technical Data

Camera head:	<ul style="list-style-type: none"> <li>• Aspect ratio: 16:9</li> <li>• Image sensor: 1/3" CMOS</li> <li>• Immersible (using the attached cap)</li> </ul>	<ul style="list-style-type: none"> <li>• Waterproof keyboard</li> <li>• Footswitch</li> </ul>
Voltage range (current consumption):	• 100-240 V (95 VA)	
Frequency:	• 50-60 Hz (interlaced scan)	
Device protection:	• 2x T3,15 A	
Video system:	<ul style="list-style-type: none"> <li>• Image resolution: full HD 1920 x 1080</li> <li>• White balance automatically, with data hold</li> <li>• shutter speed: 1/50 (1/60) to 1/100.000 sec</li> </ul>	<ul style="list-style-type: none"> <li>• TV resolution: &gt; 900 lines</li> <li>• Sensitivity: &lt; 3 lux (1/1.4)</li> </ul>
Recording (optional)	<ul style="list-style-type: none"> <li>• Image format: JPG 1920 x 1080</li> <li>• Video format: Full HD 1920 x 1080; Mpeg-4 (H.264 Codec); Image rate 60fps</li> <li>• Connection: USB (A)</li> </ul>	
Lamp:	• LED lamp, comparable 50 W	
Light guide connection:	• Storz	
Connections	Video out terminal: • 1x HDMI	Other connections: • 1x USB (Keyboard) • 1x Remote IN (footswitch) • 1x RJ45 (Service) • 1x Remote OUT (external devices)
Protection class (acc.to IEC 60601-1):	• I	
Safety class:	• BF	
IP code:	• 20	
Standard:	• IEC 60601-1-2	
Device classification (EU) 2017/745, annex VIII:	• I	
Features:	<ul style="list-style-type: none"> <li>• White balance, boost function</li> <li>• On-screen-menu</li> <li>• 3 user settings storable</li> </ul>	<ul style="list-style-type: none"> <li>• 2.5 digital zoom</li> <li>• Freeze function</li> <li>• Character generator</li> </ul>
Dimensions:	• Control unit: 295 x 128 x 278mm (WxHxD); Weight: approx. 5 kg	
Delivery contains:	• CCU, camera head with 3,05m (10ft) cable, mains cable, HDMI cable, user manual	

<b>Series</b>	Recording (Video & Image)	1MOS camera	LED
---------------	---------------------------	-------------	-----

<b>LED 50-HD USB</b>	x	x	x
<b>LED 50-HD</b>	-	x	x

### Camera head without push buttons



Weight: approx. 150g  
Size: d= 36,5mm; l= 65mm  
(without bending sleeve)

### Camera head with push buttons



Weight: approx. 180 g  
Size: d= 38mm; l= 79mm  
(without bending sleeve)

## Zubehör

### *Accessories*



**Sterilisations- und Aufbewahrungszubehör**  
*Sterilizing and Storage Accessories*

Schutzhülse für Endoskope / Protecting Sleeve for endoscopes	Für Endoskop-Ø in mm For Endoscope-Ø in mm	Abmessung in mm (L x B x H) Dimensions in mm (l x w x h)	Material Material	Bestell-Nr. Ordering number
	≤ 5		Kunststoff plastic	AEA020-000-000

**Schutzhülse für die Sterilisation und Aufbewahrung von Elektroden, Küretten und Skalpelle**  
*Protecting sleeve for the sterilization and storage of Electrodes, Curettes and Scalpels*

			rostfreier Stahl stainless steel	AEA030-000-000
---	--	--	-------------------------------------	----------------

**Siebkorb für 1 Endoskop / Wire basket for one endoscope**

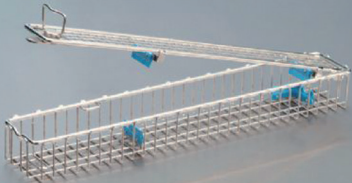
	1,0 – 10,0	290 x 80 x 52	rostfreier Stahl stainless steel	74-600-030
		460 x 80 x 52		74-600-040
		670 x 80 x 52		74-600-070

**Siebkorb für 2 Endoskope / Wire basket for two endoscopes**

	1,0 – 10,0	290 x 80 x 52	rostfreier Stahl stainless steel	74-600-050
		460 x 80 x 52		74-600-060

**Schlauchverbinder**  
*Tubing Connectors*

**Luer-Lock-Schlauchverbinder**  
Luer-Lock Tubing Connector



**Luer-Lock-Schlauchverbinder mit Hahn**  
Luer-Lock Tubing Connector with Stopcock

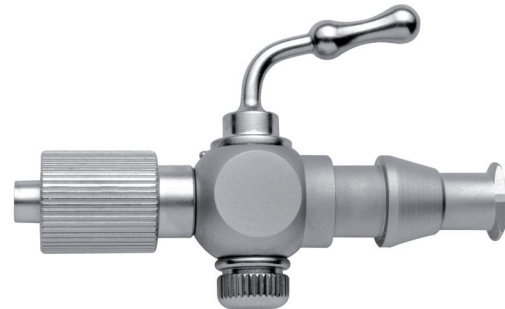

Bohrungs - Ø Bore - Ø	Bestell-Nr. Ordering number	Bohrungs - Ø Bore - Ø	Bestell-Nr. Ordering number
3,0 mm	AEA100-030-000	3,0 mm	AEA110-030-000

**Gummikappe**  
*Rubber Cap*

**Gummikappe / Rubber Cap**



	Bestell-Nr. Ordering number
für Instrumentenkanal/for instrument channel	AEA010-010-000

**Reinigungsbürsten mit Kunststoffgriff, halbstarr**  
*Cleaning Brushes with Plastic Handle, semi-rigid*



Reinigungsbürste / Cleaning Brush



	Nutzlänge Working length	Durchmesser Diameter	Bestell-Nr. Ordering number
	330 mm	3,0 mm	AEA900-030-330
	450 mm		AEA900-030-450
	330 mm	5,0 mm	AEA900-050-330
	450 mm		AEA900-050-450
	330 mm	10,0 mm	AEA900-100-330
	450 mm		AEA900-100-450



# emos technology

EMOS Technology GmbH  
Gewerbestr. 10  
D-88636 Illmensee

fon +49 (0) 75 58 / 93 82 78 - 0  
fax +49 (0) 75 58 / 93 82 78 - 55

E-Mail: [info@emostechnology.com](mailto:info@emostechnology.com)  
[www.emostechnology.com](http://www.emostechnology.com)

